

# BE RELENTLESS

We're 700 American craftsmen making innovative, battle-proven optics for the world's most relentless hunters and shooters. We design, build, and test our products with a single-minded focus: to make sure they'll perform forever.

No matter where you take us, on the battlefield, in competition, or on the hunt, we won't let you down. So be bold. Be tenacious. Be relentless.



# WE GUARANTEE A LIFETIME OF PERFORMANCE

A warranty that replaces broken optics doesn't do you any good when you're eight miles deep into the backcountry. That's why Leupold products are guaranteed to perform in the harshest conditions, shot after shot, year after year.



#### **Leupold's Lifetime Guarantee**

If your Leupold riflescope, binocular, or spotting scope doesn't perform, we will repair or replace it for free - whether you're the original owner or not. You don't need proof of ownership or a warranty card, and there's no time limit. We do this because we believe in superior quality and craftsmanship, and we're confident your Leupold won't let you down.



#### **Leupold Electronics Limited Two-Year Warranty**

Leupold electronic products, which include rangefinders, thermal products, and other electronic devices, are warrantied against defects in materials and workmanship for two-years from the date of purchase. If the product is found to be defective, Leupold & Stevens Inc. will repair or replace it free of charge, within that two-year period. Proof of purchase may be required to verify warranty.

#### **Leupold Military and Tactical Products**

Certain customer contracts for Military and Law Enforcement entities may specify a product warranty that supersedes the above consumer warranty.

International customers may be affected by embargoes and other trade restrictions. Please contact us if you are an international warranty customer prior to sending your scope to us for repair.

#### **For questions or service**

Please call 1-800-LEUPOLD or (503) 526-1400.

#### **Warranty Exclusions**

These warranties do not apply if the product has been modified, misused or has been damaged by accident, abuse, or misapplication. To ensure this doesn't happen to you, contact Leupold Product Service before having any work or repairs done to your Leupold optics. Call 1-800-LEUPOLD or (503) 526-1400.

Warranty Products which are unclaimed after a period of one year may be subject to forfeiture.

This warranty gives you specific legal rights, and you may also have other rights which vary from state to state.

# RELENTLESS INNOVATION

Always innovating. Relentless performance requires that we're constantly pushing ourselves and our products to their limits. Finding out what works, what doesn't, and what you need to be successful in the field. Leupold was born from the idea that we can do it better than anyone else, which still holds true today. Our elite team of almost 100 engineers share one goal – build products that are guaranteed to perform for life.

## **Twilight Max HD**

Representing the pinnacle of our in-house lens design, the Twilight Max HD Light Management System is built to deliver unbelievable image quality in the harshest lighting conditions.

- Maximizes ambient light in extreme low-light environments
- Excellent glare management and virtually eliminates image wash-out caused by stray light
- Premium High Definition edge-to-edge lens clarity

## **Twilight Max**

With true dawn-to-dusk performance, the Twilight Max Light Management System is designed to perform in a wide variety of lighting conditions without fail.

- Intensifies ambient light in low-light environments
- Great glare management and drastically reduces image wash-out caused by stray light
- Premium edge-to-edge lens clarity

## **Twilight**

Proving that you don't have to compromise even when you're on a budget, our Twilight Light Management System delivers unbeatable, class-leading low-light performance.

- Amplifies ambient light in low-light environments
- Good glare management and minimizes image wash-out caused by stray light
- Premium lens clarity

## **Guard-ion Hydrophobic Lens Coating**

Acts as a guardian for your lenses, keeping them clean and clear with our proprietary coating that sheds water, dirt, oils, and more.

## **Scratch Resistant Lenses**

Provides added lens durability that far exceeds industry standards.

## **Motion Sensor Technology**

Always be ready to go with motion activated reticle illumination. It extends battery life by shutting off illuminated reticles after five minutes of inactivity and instantly turns on when moved.

## **True Ballistic Range (TBR)**

Only Leupold RX® rangefinders with True Ballistic Range® take into account the angle of your shot and your rifle's ballistics to put you dead on. Other rangefinders can't give you an accurate range to your target because they use basic trigonometry to calculate a straight-line horizontal distance (the so-called "rifleman's rule").

## **True Ballistic Range/Wind (TBR/W)**

True Ballistic Range/Wind technology in Leupold RX rangefinders accounts for wind out to distances of up to 800 yards. It generates a hold point for a 10-mph wind at a 90° angle to your direction of aim.

## **Trophy Scale**

Take the guess work out of accurately measuring the width or height of an animal's antlers with our proprietary software found in select RX Rangefinder models.

## **Custom Dial System (CDS)**

CDS simplifies longer shots by eliminating the need for holdovers or ballistic calculations, using a custom dial that's specific to your rifle and ammo.

# COMPLETE SHOOTING SYSTEM

From locating animals at any distance all the way to recovering downed game, we've got you covered.

- 1 SPOT**  
Bino  
A wide range of magnification options and performance features help you tackle any environment on any budget.
- 2 IDENTIFY**  
Spotter  
Rugged, high-magnification optics ensure you know exactly what you're going after in any terrain.
- 3 RANGE**  
Rangefinder  
Lightning quick ranging engines combined with advanced ballistic calculations deliver the industry's most accurate distances.
- 4 DIAL**  
CDS  
Our game-changing Custom Dial System eliminates the need for holdovers, making longer-range shots easier than ever.
- 5 SHOOT**  
Scope  
Our rugged and reliable riflescopes are waterproof, fogproof, and guaranteed to perform for life.
- 6 RECOVER**  
Thermal  
Highly-sensitive and easy-to-use thermal devices make finding downed game easier than ever.

# LEUPOLD'S TWILIGHT LIGHT MANAGEMENT SYSTEMS

## DELIVERING INDUSTRY-LEADING BRIGHTNESS AND CLARITY

Each Twilight Light Management system builds on the previous one to ensure every Leupold product has the clearest, brightest image in its class.

While our standard Twilight Light Management system outperforms most optics on the market, we upped our game with Twilight Max HD. Boasting an elite optical design and 3x more lens coatings, it creates some of the brightest optics, no matter the lighting conditions.

## WHICH LIGHT MANAGEMENT SYSTEM IS RIGHT FOR YOU?

 <b>LEUPOLD</b>	Twilight	Twilight Max	Twilight Max HD
	Bright	Brighter	Brightest
Light Transmission	Amplifies ambient light in low-light environments	Intensifies ambient light in low-light environments	Maximizes ambient light in extreme low-light environments
Glare Management	Good glare management and minimizes image wash-out caused by stray light	Great glare management and drastically reduces image wash-out caused by stray light	Excellent glare management and virtually eliminates image wash-out caused by stray light
Contrast & Resolution	Premium lens clarity	Premium edge-to-edge lens clarity	Premium High Definition edge-to-edge lens clarity

# CUSTOM DIAL SYSTEM (CDS)

By providing the specific ballistics to your rifle and ammunition, Leupold can create a custom dial for simplified long-range shooting.



## RANGE IT

If the object is 600 yards away

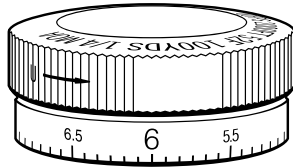

## DIAL IT

Turn the dial to 6

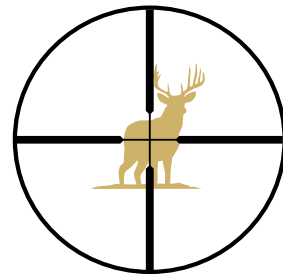

## AIM DEAD ON

No more worrying about hold-overs

### BALLISTIC INFO REQUIRED

Caliber	Average temperature (dial is accurate +/- 20 degrees)
Bullet type	
Bullet weight	Sight height (center of scope to center of barrel)
Muzzle velocity	
Average elevation (dial is accurate +/- 2000 ft)	Zero distance (usually 100 or 200 yards)
Serial number of scope	Ballistic coefficient

If you don't know where to find your specific ballistic information, visit [customshop.leupold.com/faqs](http://customshop.leupold.com/faqs), or call 1-800-LEUPOLD.

### ORDER YOUR DIAL TODAY

Order online at [www.leupold.com/freecd](http://www.leupold.com/freecd).

All CDS-equipped scopes qualify for one FREE DIAL; additional dials are \$80.00 each.

# THE LEUPOLD PUNISHER PROCESS

Our rigorous testing process goes above and beyond to make sure every scope holds up to a lifetime of abuse.



## WATERPROOFING AND FOGPROOFING

From torrential downpours to crossing rivers, you'll never have to worry about a Leupold scope leaking or fogging up. Our proprietary waterproofing process includes submersion testing to a depth of 33-feet and a multitude of pressure changes.



## IMPACT TESTED AND VERIFIED

We purpose built a machine to replicate the most extreme impact signature imaginable. The actual rifle doesn't exist, but if it did, and you shot it, you would instantly regret it. You would be knocked unconscious, suffer a concussion, burst blood vessels in your eyes, and detach your retinas. Every scope we make, from a \$200 VX-Freedom, to our \$4500 Mark 8 has to survive 5000 impacts at this energy, all while retaining its functionality and holding a perfect zero.

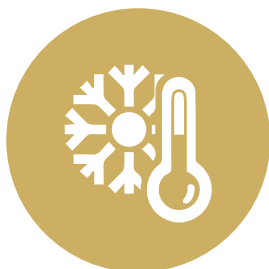

## EXTREME CLIMATE EXPOSURE

We make sure our optics perform at the highest level in the harshest conditions by ensuring they will work from -40 degrees Fahrenheit all the way up to 160 degrees Fahrenheit.





# COMPARISON CHART

Product	VX-6HD	VX-8HD	VX-31	VX-Freedom	Rifleman	FX	Handgun
Light Management System	Twilight Max HD	Twilight Max HD	Twilight Max	Twilight	Twilight	Twilight	Twilight
Zoom Ratio	6:1	5:1	3:1	3:1	3:1	Fixed	Fixed, 3:1
Dial System	1/4 MOA ZeroLock-2 0.1 Mil* ZeroLock-2 CDS included	1/4 MOA Finger Click 1/4 MOA ZeroLock-2 0.1 Mil* Finger Click 0.1 Mil* ZeroLock-2 CDS available	1/4 MOA click 0.1 Mil* Finger Click CDS available	1/4 MOA Finger Click 0.1 Mil* Finger Click CDS available	Micro-friction	Micro-friction Finger click	Finger click
Magnification	1-6 2-12 3-18 4-24	1-5 2-10 3-15 4-20 7-35	1.5-5 2.5-8 3.5-10 4.5-14 6.5-20	1.5-4 2-7 3-9 4-12 6-18	3-9 4-12	2.5 4 6	4 2.5-8
Maintube Size	30 mm 34 mm	30 mm 34 mm	1 inch 30 mm	1 inch 30 mm	1 inch	1 inch	1 inch
Extra Features	Reversible throw lever Guard-ion coating Electronic reticle leveling system Punisher impact tested and verified Fogproof and waterproof	Wide angle field-of-view Guard-ion coating Punisher impact tested and verified Fogproof and waterproof	Ultra light weight and compact Scratch-resistant lenses Punisher impact tested and verified Fogproof and waterproof	Scratch-resistant lenses Quick-grip power selector Punisher impact tested and verified Fogproof and waterproof	Punisher impact tested and verified Fogproof and waterproof	Punisher impact tested and verified Fogproof and waterproof	Punisher impact tested and verified Fogproof and waterproof

\*0.1 Mil = 1cm at 100 Meters



# HUNTING DIAL GUIDE

Why doesn't every riflescope use the same dials? Because you need the right tool for the job.



### CDS Dials

Low-profile, click adjustments. Can be laser engraved with your custom load info and range markings. No cover to lose. Your first CDS dial is engraved for free, when you purchase any CDS-ready riflescope.



### Finger Click Adjustment Dials

Low-profile, covered dials. Fast, precise sight-in without coins or tools.



### CDS-ZeroLock Dials

Low-profile, one revolution, CDS-ready dials. The ZeroLock (ZL) ensures your dial only moves when you want it to. Push the button to unlock it and dial, then simply rotate it back to zero to lock it back in place. Can be laser engraved with your custom load information.



### Coin Click Dials

Easily adjusted with a coin, turret cap, or tool. Low-profile, covered dials. Fast, precise sight-in. Reset ring and index mark makes returning to zero simple.



### CDS-ZeroLock-2 Dials

Low-profile, two revolution, CDS-ready dials. The ZL2 release button protrudes on the first revolution and is flush on the second. Can be laser engraved with your load info and range markings.



### Micro-Friction Adjustments

Marked in easy-to-read increments. Low-profile, covered dials. Set it and forget it.



### CDS-TZL3 Dials

Large, three revolution dial designed for precision adjustments. CDS-TZL3 dial features a re-settable zero lock and an easy-to-read rotation indicator so you know how far you've dialed.



### Pop Up Rezero Dial

Easily align the zero on the dial to the index mark on the housing by popping up, spinning, and snapping down the dial.

Elevation Adjustment Type	Click Increment	Adjustment Per Revolution	Lock Type	Dial Travel Limit	Re-zero Type	Revolution Indicator	Custom Ballistic Lasering Compatible
Finger Click	1/4 MOA, 0.1 Mil*	15 MOA, 60 cm	None	Total scope travel	Index ring	No	No
CDS	1/4 MOA, 0.1 Mil*	15 MOA, 60 cm	None	Total scope travel or 14 MOA with custom ballistic dial with zero-stop	Dial slip	No	Yes
CDS-ZL	1/4 MOA	15 MOA	Push button	14 MOA	Dial slip	No	Yes
CDS-ZL2	1/4 MOA, 0.1 Mil*	20 MOA, 80 cm	Push button	38 MOA	Dial slip	Yes	Yes
CDS Target (VX-6 7-42x56)	1/8 MOA	20 MOA	None	Total scope travel	Dial slip	Yes	Yes
CDS Target (VX-3i)	1/4 MOA	15 MOA	None	Total scope travel	Dial slip	Yes	Yes
CDS-TZL3	1/4 MOA	20 MOA	Push button	58 MOA	Dial slip	Yes	Yes

\*0.1 Mil = 1 cm at 100 Meters

# VX-6HD



All-around domination. The VX-6 HD takes 70+ years of riflescope design and delivers performance that re-defines what a premium riflescope is. Its wide magnification range is ready for any terrain on any continent. It's built for the hunter who needs every feature at their disposal and refuses to compromise.

## KEY BENEFITS

### See more in less light with Twilight Max HD Light Management System

- Maximizes ambient light in extreme low-light environments
- Excellent glare management and virtually eliminates image wash-out caused by stray light
- Premium High Definition edge-to-edge lens clarity

### Eliminates accidental dial movement with the push-button ZeroLock system

### Simplifies mounting and improves long-range accuracy with electronic leveling system

### Sheds dirt and water for clear, crisp images with Guard-ion lens coating

### Creates a visible aiming point in low-light conditions with illuminated reticles

### Extends battery life with Motion Sensor Technology (MST)

### Brings the reticle into focus quickly with Fast-focus eyepiece

### Allows for quick magnification changes with reversible throwlever

### Disperses recoil energy for unrivaled durability with ultra-lightweight construction

### Superior ruggedness is verified through Leupold's Punisher testing process

### Waterproof, fogproof, and guaranteed to perform for life

## MAGNIFICATION RANGES

1-6x24



2-12x42



3-18x44



3-18x50



4-24x52



# VX-6HD

VX-6HD	A	B	C	D	E	F	G	H	K	Obj. (mm)	Weight (oz)	Eye Relief Low/High (in)	FOV Low/High (ft @ 100 yd)	Elev. Adj. MOA	Wind Adj. MOA	Part Number	UPC Code
1-6x24 CDS-ZL2	10.8	6.8	2.9	2.6	3.3	1.2	1.8	1.8	30mm	24	16.2	3.7/3.8	120.9/19.2	170	170	A 171552	030317012441
2-12x42 CDS-ZL2	12.6	5.6	1.7	2.6	3.3	3.6	2.0	1.8	30mm	42	19.7	3.7/3.8	56.5/9.6	120	120	A 171563	030317012373
2-12x42 CDS-ZL2 GORE Optifade Subalpine*	12.6	5.6	1.7	2.6	3.3	3.6	2.0	1.8	30mm	42	19.7	3.7/3.8	56.5/9.6	120	120	D 172955	030317015961
3-18x44 CDS-ZL2	13.5	5.4	1.3	2.6	3.3	4.8	2.1	1.8	30mm	44	21.3	3.7/3.8	38.3/6.4	75	75	A 171565	030317012410
																C 171568	030317012656
3-18x44 CDS-ZL2 GORE Optifade Subalpine*	13.5	5.4	1.3	2.6	3.3	4.8	2.1	1.8	30mm	44	21.3	3.7/3.8	38.3/6.4	75	75	D 173209	030317016203
3-18x50 CDS-ZL2	13.5	5.3	1.3	2.6	3.3	4.9	2.3	1.8	30mm	50	20.7	3.7/3.8	38.3/6.4	75	75	A 171572	030317012694
																B 171573	030317012663
																C 171576	030317012397
																D 179292	030317026028
4-24x52 CDS-ZL3	14.7	6.2	2.1	2.6	3.3	5.1	2.4	1.8	34mm	56	23.7	3.7/3.8	28.1/4.8	75	75	E 179293	030317026042
																A 179294	030317026035

## SCOPE DIMENSIONS

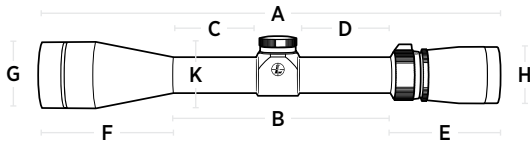

## KEY FEATURES

- Twilight Max HD Light Management System
- 6:1 zoom ratio
- 30mm and 34mm maintubes
- Fast-focus eyepiece
- Guard-ion lens coatings
- Scratch-resistant lenses
- Reversible throw lever
- Motion Sensor Technology (MST)
- CDS-ZL2 dial
- FireDot illumination
- Push-button illumination
- Lightweight design
- Alumina Flip-Back lens covers
- Waterproof
- Fogproof
- Guaranteed for life

## AVAILABLE RETICLES

■ Illuminated Reticle

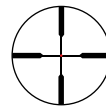

**A** FireDot Duplex

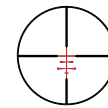

**B** Illuminated Boone & Crockett



**C** Illuminated TMOA

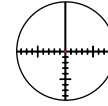

**D** FireDot Tri-MOA

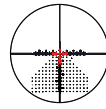

**E** Illuminated Impact-23 MOA

\* Available at select dealers

# VX-5HD



The VX-5HD defines relentless versatility. Its wide magnification ranges give hunters and shooters the ability to adapt to any environment. With the Twilight Max HD Light Management System, it's purpose built for the most extreme lighting conditions. Rugged and reliable, the VX-5HD is ready for your next adventure.

## KEY BENEFITS

### See more in less light with Twilight Max HD Light Management System

- Maximizes ambient light in extreme low-light environments
- Excellent glare management and virtually eliminates image wash-out caused by stray light
- Premium High Definition edge-to-edge lens clarity

### Eliminates accidental dial movement with the push-button ZeroLock system

### Creates more adjustment travel for longer shots with available 30mm and 34mm maintubes

### Sheds dirt and water for clear, crisp images with Guard-ion lens coating

### Creates a visible aiming point in low-light conditions with available illuminated reticles

### Extends battery life with Motion Sensor Technology (MST)

### Brings the reticle into focus quickly with Fast-Focus eyepiece

### Superior ruggedness is verified through Leupold's Punisher testing process

### Disperses recoil energy for unrivaled durability with ultra-lightweight construction

### Waterproof, fogproof, and guaranteed to perform for life

## MAGNIFICATION RANGES

1-5x24

2-10x42

3-15x44

3-15x56

4-20x52

7-35x56



# VX-5HD

VX-5HD	A	B	C	D	E	F	G	H	K	Obj. (mm)	Weight (oz)	Eye Relief Low/High (in)	FOV Low/High (ft @ 100 yd)	Elev. Adj. MOA	Wind Adj. MOA	Part Number	UPC Code
1-5x24 Pop Up Rezero Dial	10.8	6.8	2.9	2.6	3.3	-	1.2	1.8	30mm	24	13.7	3.7/3.8	120.9/40.3	170	170	<b>B</b> 171385 - Metric	030317012199
1-5x24 CDS-ZL2	10.8	6.8	2.9	2.6	3.3	-	1.2	1.8	30mm	24	14.7	3.7/3.8	120.9/40.3	170	170	<b>C</b> 172367	030317013875
2-10x42 Pop Up Rezero Dial	12.6	5.6	1.7	2.6	3.3	3.6	2.0	1.8	30mm	42	16.9	3.7/3.8	56.5/11.5	120	120	<b>A</b> 171386	030317012144
2-10x42 CDS-ZL2	12.6	5.6	1.7	2.6	3.3	3.6	2.0	1.8	30mm	42	17.9	3.7/3.8	56.5/11.5	120	120	<b>C</b> 171389	030317012151
3-15x44 CDS-ZL2	13.5	5.4	1.3	2.6	3.3	4.8	2.1	1.8	30mm	44	19.7	3.7/3.8	38.3/7.7	75	75	<b>A</b> 171714	030317012861
																<b>C</b> 172368	030317013851
																<b>D</b> 171715	030317012854
																<b>E</b> 171716	030317012847
																<b>F</b> 171717	030317012878
																<b>I</b> 178027	030317023867
3-15x56 CDS-ZL2	13.6	5.3	1.3	2.6	3.3	4.9	2.5	1.8	30mm	56	21.9	3.7/3.8	38.3/7.7	75	75	<b>C</b> 171390	030317012212
																<b>B</b> 175834 - Metric	030317020439
4-20x52 CDS-ZL2	14.7	6.2	2.1	2.6	3.3	5.1	2.4	1.8	34mm	52	23.3	3.7/3.8	28.4/7.7	80	75	<b>A</b> 171701	030317012809
4-20x52 CDS-TZL3	14.7	6.2	2.1	2.6	3.3	5.1	2.4	1.8	34mm	52	23.5	3.7/3.8	28.1/5.8	80	75	<b>G</b> 171700	030317012793
7-35x56 CDS-TZL3	15.6	6.9	2.8	2.7	3.3	5.4	2.4	1.8	34mm	56	25.9	3.7/3.8	16.3/3.1	55	40	<b>G</b> 172754	030317015633
																<b>H</b> 173221	030317016258

## SCOPE DIMENSIONS

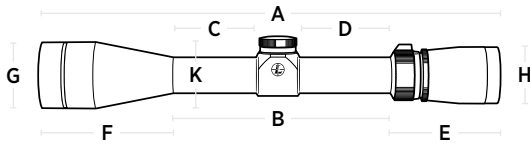

## KEY FEATURES

- |   |                                     |
|---|-------------------------------------|
| Twilight Max HD Light Management System | Available CDS-ZL2 and CDS-TZL3 dial |
| 5:1 zoom ratio                          | Available FireDot illumination      |
| 30mm and 34mm maintubes                 | Push-button illumination            |
| Fast-focus eyepiece                     | Lightweight design                  |
| Guard-ion lens coatings                 | Waterproof                          |
| Scratch-resistant lenses                | Fogproof                            |
| Motion Sensor Technology (MST)          | Guaranteed for life                 |

## AVAILABLE RETICLES

■ Illuminated Reticle

- |  |  |  |                                       |
|--|--|--|---------------------------------------|
|  | <b>A</b><br>Duplex                       |  | <b>B</b><br>FireDot 4 Fine            |
|  | <b>C</b><br>FireDot Duplex               |  | <b>D</b><br>Wind-Plex                 |
|  | <b>E</b><br>Illuminated Boone & Crockett |  | <b>F</b><br>Illuminated Impact-29 MOA |
|  | <b>G</b><br>TMOA                         |  | <b>H</b><br>Impact-14 MOA             |
|  | <b>I</b><br>HTMR                         |  |                                       |

# VX-3i



The VX3i delivers outstanding performance in low-light conditions and an incredibly tough, lightweight design. Our Twilight Max Light Management System lets you see details others can't in those crucial low-light situations at the beginning and the end of the day. Everything we put into the VX-3i is there to help you tag out.

## KEY BENEFITS

### See more in less light with Twilight Max Light Management System

- Intensifies ambient light in low-light environments
- Great glare management and drastically reduces image wash-out caused by stray light
- Premium edge-to-edge lens clarity

Offers ultra-lightweight 1-inch maintube models or 30mm models for increased adjustment travel

Eliminates the need for holdovers on longer shots with the optional Custom Dial System

Disperses recoil energy for unrivaled durability with ultra-lightweight construction

Superior ruggedness is verified through Leupold's Punisher testing process

Waterproof, fogproof, and guaranteed to perform for life

## MAGNIFICATION RANGES

1.5-5x20



2.5-8x36



3.5-10x40



3.5-10x50



4.5-14x40



4.5-14x50



6.5-20x40



6.5-20x50



# VX-3i

VX-3i	A	B	C	D	E	F	G	H	K	Obj. (mm)	Weight (oz)	Eye Relief Low/High (in)	FOV Low/High (ft @ 100 yd)	Elev. Adj. MOA	Wind Adj. MOA	Part Number	UPC Code
1.5-5x20	9.7	6.0	2.3	2.5	3.1	-	1.0	1.6	1.0	20	9.3	4.4/3.6	67.6/24.1	110	110	<b>A</b> 170675	030317010270
2.5-8x36	11.4	5.2	1.6	2.5	3.1	3.1	1.7	1.6	1.0	36	11.4	4.4/3.6	37.5/13.7	65	65	<b>A</b> 170678	030317010072
3.5-10x40	12.7	6.0	2.3	2.5	3.1	3.6	1.8	1.6	1.0	40	12.6	4.4/3.6	29.0/11.0	57	57	<b>A</b> 170680	030317010126
3.5-10x40 CDS-ZL	12.7	6.0	2.3	2.5	3.1	3.6	1.8	1.6	1.0	40	13.1	4.4/3.6	29.0/11.0	57	57	<b>A</b> 177823	030317023560
3.5-10x50	12.3	5.3	1.6	2.5	3.1	3.9	2.3	1.6	1.0	50	14.7	4.4/3.6	22.7/11.0	55	55	<b>A</b> 170684	030317009922
4.5-14x40	12.7	6.0	2.3	2.5	3.1	3.6	1.8	1.6	1.0	40	13.0	4.4/3.6	19.9/7.4	65	65	<b>A</b> 170689	030317010133
4.5-14x40 CDS-ZL	12.7	6.0	2.3	2.5	3.1	3.6	1.8	1.6	1.0	40	13.5	4.4/3.6	19.9/7.4	65	65	<b>D</b> 170690	030317010225
4.5-14x40 Side Focus CDS-ZL	12.7	6.0	2.3	2.5	3.1	3.6	1.8	1.6	30mm	40	15.6	4.4/3.6	19.9/7.4	110	110	<b>A</b> 177861	030317023713
4.5-14x40 Side Focus CDS-ZL	12.7	6.0	2.3	2.5	3.1	3.6	1.8	1.6	30mm	40	15.6	4.4/3.6	19.9/7.4	110	110	<b>C</b> 177820	030317023577
4.5-14x50	12.3	5.3	1.6	2.5	3.1	3.9	2.3	1.6	1.0	40	16.5	4.4/3.6	20.5/7.6	65	65	<b>A</b> 170704	030317010331
4.5-14x50 Side Focus	12.3	5.3	1.6	2.5	3.1	3.9	2.3	1.6	30mm	50	16.5	4.4/3.6	20.5/7.6	110	110	<b>A</b> 170709	030317010164
4.5-14x50 Side Focus CDS-ZL	12.3	5.3	1.6	2.5	3.1	3.9	2.3	1.6	30mm	50	17.0	4.4/3.6	20.5/7.6	110	110	<b>A</b> 177822	030317023553
6.5-20x40 EFR CDS Target	14.5	6.5	2.9	2.3	3.2	4.7	2.0	1.6	1.0	40	17.8	4.4/3.6	14.3/5.5	49	49	<b>B</b> 170885	030317011086
6.5-20x50 Side Focus CDS Target	14.4	6.4	2.8	2.5	3.1	4.9	2.3	1.6	30mm	50	20.4	4.4/3.6	14.1/5.8	80	80	<b>B</b> 170714	030317009960

## SCOPE DIMENSIONS

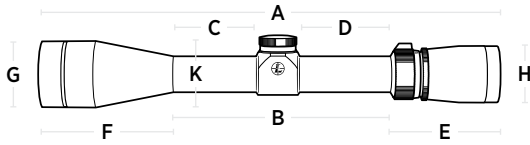

## KEY FEATURES

- Twilight Max Light Management System
- 3:1 zoom ratio
- 1-inch and 30mm maintubes
- Locking eyepiece
- Scratch-resistant lenses
- Available CDS dial
- Ultra-lightweight design
- Waterproof
- Fogproof
- Guaranteed for life

## AVAILABLE RETICLES

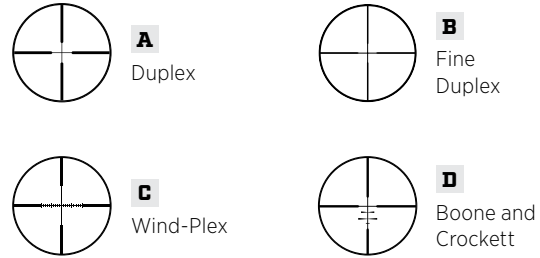



# VX-FREEDOM



The new VX-Freedom delivers the legendary Leupold performance and dependability hunters and shooters have demanded for decades, combined with a host of new and improved features. The VX-Freedom will get the job done every time and carries the same lifetime guarantee as all Leupold riflescopes.

## KEY BENEFITS

### See more in less light with Twilight Light Management System

- Amplifies ambient light in low-light environments
- Good glare management and minimizes image wash-out caused by stray light
- Premium lens clarity

### Eliminates holdovers on longer shots with the optional Custom Dial System

### Quickly change magnifications using the easy-to-grip power selector

### Disperses recoil energy for unrivaled durability with ultra-lightweight construction

### Superior ruggedness is verified through Leupold's Punisher testing process

### Creates a visible aiming point in any light condition with FireDot illumination

### Increases adjustment for longer shots with a 30mm maintube

### Extends battery life with Motion Sensor Technology (MST)

### Waterproof, fogproof, and guaranteed to perform for life

## MAGNIFICATION RANGES

1.5-4x20



1.5-4x28 Scout



2-7x33



3-9x33 EFR



3-9x40



3-9x40 30mm



3-9x50



4-12x40



4-12x40 30mm



6-18x40 30mm



# VX-FREEDOM

VX-Freedom	A	B	C	D	E	F	G	H	K	Obj. (mm)	Weight (oz)	Eye Relief Low/High (in)	FOV Low/High (ft @ 100 yd)	Elev. Adj. MOA	Wind Adj. MOA	Part Number	UPC Code
1.5-4x20	9.4	5.4	2.2	1.9	3.5	0.5	1.0	1.6	1.0	20	9.6	4.2/3.7	74.2/29.4	125	125	<b>A</b> 174176 <b>B</b> 174177	030317018795 030317018733
1.5-4x20	9.5	5.2	2.1	1.9	3.6	0.6	1.2	1.6	30mm	20	12.25	4.2/3.7	74.2/29.4	125	125	<b>I</b> 177225	030317022464
1.5-4x28 Scout	11.1	4.5	1.4	1.9	4.2	2.3	1.6	1.4	1.0	28	9.6	6.9/6.0	41.7/17.3	67	67	<b>A</b> 175074	030317018979
2-7x33	11.0	4.8	1.7	1.9	3.5	2.7	1.6	1.6	1.0	33	11.1	4.2/3.7	43.8/29.8	75	75	<b>A</b> 174178	030317018726
2-7x33 Rimfire	11.0	4.8	1.7	1.9	3.5	2.7	1.8	1.6	1.0	33	11.1	4.2/3.7	43.8/29.8	75	75	<b>C</b> 174179	030317018719
3-9x33 EFR	11.6	4.8	1.7	1.9	3.4	3.4	1.8	1.4	1.0	33	12.1	3.4/3.0	33.1/13.6	64	64	<b>A</b> 175075	030317019013
3-9x40	12.4	5.4	2.3	1.9	3.5	3.5	1.8	1.6	1.0	40	12.2	4.2/3.7	33.1/13.6	60	60	<b>A</b> 174180 <b>D</b> 174183	030317018702 030317018771
3-9x40 FireDot	12.4	5.6	2.5	1.9	3.4	3.3	1.8	1.6	30mm	40	15.4	4.2/3.7	33.1/13.6	75	75	<b>F</b> 175078 <b>I</b> 177227	030317019020 030317022518
3-9x40 Rimfire	12.4	5.4	2.3	1.9	3.5	3.5	1.8	1.6	1.0	40	12.2	4.2/3.7	33.1/13.6	60	60	<b>C</b> 174181	030317018740
3-9x40 Muzzleloader	12.4	5.4	2.3	1.9	3.5	3.5	1.8	1.6	1.0	40	12.2	4.2/3.7	33.1/13.6	60	60	<b>E</b> 174184	030317018764
3-9x40 Bushmaster	12.4	5.4	2.3	1.9	3.5	3.5	1.8	1.6	1.0	40	12.2	4.2/3.7	33.1/13.6	60	60	<b>A</b> 176011	030317020835
3-9x40 350 Legend	12.4	5.4	2.3	1.9	3.5	3.5	1.8	1.6	1.0	40	12.2	4.2/3.7	33.1/13.6	60	60	<b>A</b> 177910	030317023751
3-9x40 CDS	12.4	5.4	2.3	1.9	3.5	3.5	1.8	1.6	1.0	40	12.2	4.2/3.7	33.1/13.6	60	60	<b>A</b> 174182	030317018788
3-9x40 FireDot	12.4	5.6	2.5	1.9	3.4	3.3	1.8	1.6	30mm	40	15.4	4.2/3.7	33.7/13.6	75	75	<b>F</b> 175078	030317019020
3-9x50	12.1	4.8	1.7	1.9	3.5	3.8	2.3	1.6	1.0	50	14.6	4.2/3.7	33.1/13.6	60	60	<b>A</b> 174185	030317018757
3-9x50 FireDot	12.1	4.8	1.7	1.9	3.5	3.8	2.3	1.6	30mm	50	17.05	4.2/3.7	33.7/13.6	60	60	<b>C</b> 177228	030317022457
4-12x40	12.2	5.2	1.9	2.1	3.2	3.7	1.8	1.6	1.0	40	13.1	4.9/3.7	21.5/10.0	80	80	<b>A</b> 178253 <b>D</b> 174665	030317024260 030317018481
4-12x40 Creedmoor	12.2	5.2	1.9	2.1	3.2	3.7	1.8	1.6	1.0	40	13.1	4.9/3.7	21.5/10.0	80	80	<b>J</b> 179313	030317026059
4-12x40 CDS Side Focus	12.3	5.5	2.4	1.9	3.4	3.4	1.8	1.6	30mm	40	15.7	5.2/3.8	19.9/11.2	80	80	<b>D</b> 175079	030317018962
4-12x50	12.1	4.6	1.6	1.9	3.6	3.9	2.3	1.6	1.0	50	15	4.2/3.7	22.0/10.5	55	55	<b>A</b> 178255	030317024291
4-12x50 FireDot	12.1	4.6	1.6	1.9	3.6	3.9	2.3	1.6	30mm	50	17.45	4.2/3.7	22.0/10.5	55	55	<b>F</b> 177229	030317022495
6-18x40 CDS Side Focus	14.3	6.6	3.5	1.9	3.4	3.4	1.8	1.6	30mm	40	17	5.1/3.8	13.1/6.8	56	58	<b>D</b> 175081	030317018993

## SCOPE DIMENSIONS

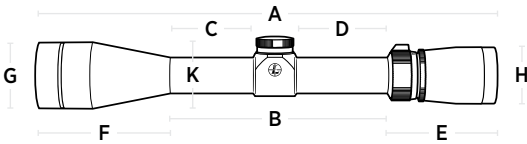

## KEY FEATURES

- Twilight Light Management System
- 3:1 zoom ratio
- 1-inch and 30mm maintubes
- Locking eyepiece
- Fast-focus eyepiece
- Scratch-resistant lenses
- Standard Finger Click Adjustments
- Available CDS dial
- High-contrast adjustment markings
- Ergonomic power selector
- Precision side focus adjustment
- Available FireDot Illumination
- Available push-button illumination
- Ultra-lightweight design
- Waterproof
- Fogproof
- Guaranteed for life

## AVAILABLE RETICLES

■ Illuminated Reticle

	<b>A</b> Duplex		<b>B</b> Pig-Plex
	<b>C</b> Rimfire-MOA		<b>D</b> Tri-MOA
	<b>E</b> UltimateSlam		<b>F</b> FireDot Duplex
	<b>G</b> FireDot Twilight Hunter		<b>H</b> FireDot Tri-MOA
	<b>I</b> FireDot MOA Ring		<b>J</b> Creedmoor

# RIFLEMAN



The Rifleman® is designed to surpass all of your expectations when it comes to repeatable accuracy. This razor-sharp optic is designed, machined, and assembled in our Oregon factory and tested to be absolutely rugged. It's 100% waterproof, fogproof, and, of course, guaranteed for a lifetime of performance.

## KEY BENEFITS

### See more in less light with Twilight Light Management System

- Amplifies ambient light in low-light environments
- Good glare management and minimizes image wash-out caused by stray light
- Premium lens clarity

Improves the sight-in process using friction adjustments

Maintains reticle focus with lockable eyepiece

Superior ruggedness is verified through Leupold's Punisher testing process

Disperses recoil energy for unrivaled durability with ultra-lightweight construction

Waterproof, fogproof, and guaranteed to perform for life

## MAGNIFICATION RANGES

3-9x40



3-9x50



4-12x40



# RIFLEMAN

Rifleman	A	B	C	D	E	F	G	H	K	Obj. (mm)	Weight (oz)	Eye Relief Low/High (in)	FOV Low/High (ft @ 100 yd)	Elev. Adj. MOA	Wind Adj. MOA	Part Number	UPC Code
3-9x40 Micro-Friction	12.4	5.4	2.1	2.1	3.2	3.7	1.8	1.6	1.0	40	12.6	4.2/3.7	33.7/13.6	60	60	<b>A</b> 56160	30317561604
3-9x50 Micro-Friction	12.1	4.8	1.5	2.1	3.2	4.1	2.3	1.6	1.0	50	14.5	4.2/3.7	33.7/13.6	60	60	<b>A</b> 58160	30317581602
4-12x40 Micro-Friction	12.2	5.2	1.9	2.1	3.2	3.7	1.8	1.6	1.0	40	13.1	4.9/3.7	21.5/10.0	80	80	<b>A</b> 56170	30317561703

## SCOPE DIMENSIONS

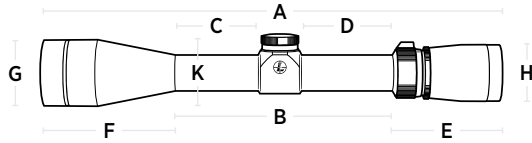

## AVAILABLE RETICLES



## KEY FEATURES

- Twilight Light Management System
- Aircraft quality aluminum
- 3:1 zoom ratio
- Waterproof
- 1-inch maintube
- Fogproof
- Locking eyepiece
- Guaranteed for life
- Micro-friction marked in 1/2 MOA increments
- Ultra-lightweight design

# FX



There's no secret to the enduring popularity of Leupold's fixed power riflescopes. Their simplicity, rugged performance, and supreme accuracy speak volumes. We put nearly a century of optical know-how into each one, ensuring they excel in brightness, contrast, and resolution. And of course, they're 100% waterproof, fogproof, and guaranteed for a lifetime of performance.

## KEY BENEFITS

### See more in less light with Twilight Light Management System

- Amplifies ambient light in low-light environments
- Good glare management and minimizes image wash-out caused by stray light
- Premium lens clarity

**Provides easy-to-use design** with fixed magnifications

**Maintains reticle focus** with lockable eyepiece

**Superior ruggedness** is verified through Leupold's Punisher testing process

**Disperses recoil energy for unrivaled durability** with ultra-lightweight construction

**Waterproof, fogproof, and guaranteed to perform for life**

## MAGNIFICATION RANGES

FX-I 4x28



FX-II 2.5x20



FX-II 2.5x28 Scout



FX-II 4x33



FX-II 6x36



FX-3 6x42



# FX

FX	A	B	C	D	E	F	G	H	K	Obj. (mm)	Weight (oz)	Eye Relief (in)	FOV (ft @ 100 yd)	Elev. Adj. MOA	Wind Adj. MOA	Part Number	UPC Code
FX-I 4x28	9.2	4.8	1.4	2.2	2.3	2.2	1.4	1.4	1.0	28	7.5	4.5	25.5	80	80	<b>C</b> 58680	030317586805
FX-II 2.5x20	8.0	5.8	1.8	2.2	2.1	-	1.0	1.4	1.0	20	6.5	4.9	39.5	147	147	<b>B</b> 58450	030317584504
FX-II 2.5x28 Scout	10.1	5.6	2.1	2.3	2.3	2.2	1.4	1.4	1.0	28	7.5	9.3	22.0	110	110	<b>A</b> 58810	030317588106
FX-3 6x42	13.2	5.4	2.0	2.2	2.5	4.0	1.9	1.6	1.0	42	13.6	4.4	17.3	70	70	<b>B</b> 66815	030317668150

## SCOPE DIMENSIONS

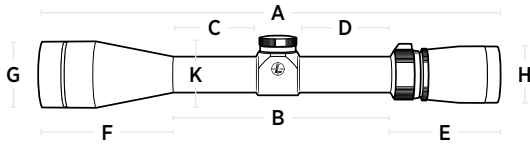

## KEY FEATURES

- Twilight Light Management System
- Fixed magnification
- 1-inch maintube
- Locking eyepiece
- Scratch-resistant lenses
- Precision click and friction adjustments
- Ultra-lightweight design
- Aircraft quality aluminum
- Waterproof
- Fogproof

## AVAILABLE RETICLES

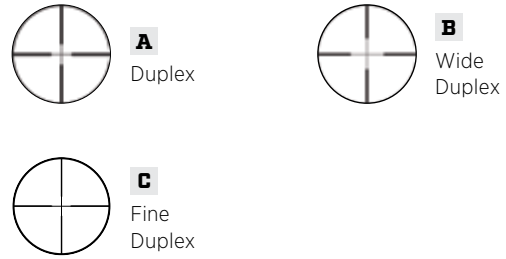

# HANDGUN



With Leupold Handgun scopes, you not only eliminate the need to focus on the front sight, you totally eliminate the inaccuracy of a handgun's short sight radius. All that's left is you, the crosshairs, and the game. These scopes can take a beating, too. They're tested to the same harsh standards as all other Leupold scopes.

## KEY BENEFITS

### See more in less light with Twilight Light Management System

- Amplifies ambient light in low-light environments
- Good glare management and minimizes image wash-out caused by stray light
- Premium lens clarity

**Simplifies mounting and improves target acquisition** with Extended Eye Relief (EER)

**Maintains reticle focus** with lockable eyepiece

**Superior ruggedness** is verified through Leupold's Punisher testing process

**Disperses recoil energy for unrivaled durability** with ultra-lightweight construction

**Waterproof, fogproof, and guaranteed to perform for life**

## MAGNIFICATION RANGES

FX-II 4x28



VX-3 2.5-8x32



# HANDGUN

Handgun	A	B	C	D	E	F	G	H	K	Obj. (mm)	Weight (oz)	Eye Relief Low/High (in)	FOV Low/High (ft @ 100 yd)	Elev. Adj. MOA	Wind Adj. MOA	Part Number	UPC Code
FX-II 4x28	8.4	4.0	1.4	1.4	2.3	2.2	1.4	1.4	1.0	28	7.0	18.0/-	9.0/-	110	110	58750	030317587505
FX-II 4x28 Silver	8.4	4.0	1.4	1.4	2.3	2.2	1.4	1.4	1.0	28	7.0	18.0/-	9.0/-	110	110	58760	030317587604
VX-3 2.5-8x32	11.4	4.1	1.4	1.5	3.0	2.5	1.7	1.7	1.0	32	10.9	15.0/15.0	12.9/4.8	110	110	67825	030317678258
VX-3 2.5-8x32 Silver	11.4	4.1	1.4	1.5	3.0	2.5	1.7	1.7	1.0	32	10.9	15.0/15.0	12.9/4.8	110	110	66620	030317666200

## SCOPE DIMENSIONS

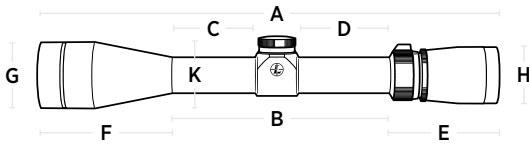

## RETICLE

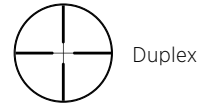

## KEY FEATURES

- Twilight Light Management System
- Ultra-lightweight design
- 1-inch maintube
- Aircraft quality aluminum
- Locking eyepiece
- Waterproof
- Handgun-specific eye relief
- Fogproof
- Scratch-resistant lenses
- Guaranteed for life
- Precision click adjustments



# AMERICAN MARKSMAN

OFFERED EXCLUSIVELY THROUGH BASS PRO SHOPS/CABELA'S



The American Marksman 3-9x40mm combines great features and unbeatable durability at an affordable price. Our Twilight Light Management System lets you see more in less light and really lets you take advantage of the first and last 10 minutes of the day when animals are the most active. Precise adjustments and the LR Wind-Plex reticle ensure that whether you're dialing or using the reticle hold-overs, you'll have the right tool for the job. The American Marksman is 100% fogproof, waterproof, Punisher tested and verified, and is backed by Leupold's Full Lifetime Guarantee.

## KEY BENEFITS

### See more in less light with Twilight Light Management System

- Amplifies ambient light in low-light environments
- Good glare management and minimizes image wash-out caused by stray light
- Premium lens clarity

### Delivers elevation and windage holdovers for quick shot adjustments with LR Wind-Plex reticle

Improves the sight-in process with precise 1/4 MOA finger-click adjustments

### Maintains reticle focus with lockable eyepiece

Superior ruggedness is verified through Leupold's Punisher testing process

Disperses recoil energy for unrivaled durability with ultra-lightweight construction

Waterproof, fogproof, and guaranteed to perform for life



# AMERICAN MARKSMAN

American Marksman	A	B	C	D	E	F	G	H	K	Obj. (mm)	Weight (oz)	Eye Relief Low/High (in)	FOV Low/High (ft @ 100 yd)	Elev. Adj. MOA	Wind Adj. MOA	Part Number	UPC Code
3-9x40	12.4	5.4	2.3	1.9	3.5	3.5	1.8	1.6	1.0	40	11.2	4.8/3.7	33.7/13.6	60	60	173759	030317017491

## SCOPE DIMENSIONS

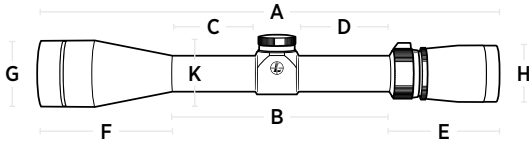







## RETICLE



## KEY FEATURES

- Twilight Light Management System
- 3:1 zoom ratio
- 1-inch maintube
- Scratch-resistant lenses
- Locking eyepiece
- Ultra-lightweight design
- Waterproof
- Fogproof
- Guaranteed for life

# COMPARISON CHART

Product	Mark 8	Mark 6	Mark 5HD	VX-31RP	VX-Freedom AR	D-310
						
Light Management System	Twilight Max HD	Twilight Max HD	Twilight Max HD	Twilight Max	Twilight	Twilight Max
Zoom Ratio	8:1	6:1	5:1	3:1	3:1	Fixed
Dial System	M5B1, M5B2, MSCZ	M6C1, M5B2, MSCZ	M5C3	Target 1/4-MOA, 1 Mil	1 Mil click	1 Mil click
Magnification	11-8 3.5-25	1-6 3-18	3.6-18 5-25 7-35	4.5-14 6.5-20 8.5-25	1.5-4 3-9 4-12 6-18	6x
Main Tube Size	34mm, 35mm	34mm	35mm	30mm	30mm 1 inch	2 inch
Extra Features	Huge forgiving eyepox Flip-Back lens covers included	Large power selector Compact design Extremely lightweight	MIL or MOA adjustments High-speed power selector with integrated throw lever Fast-focus eyepiece	MIL or MOA adjustments Elevation travel indicator Integrated power selector throw lever	Scratch-resistant lenses Quick-grip power selector Punisher impact tested and verified Fogproof and waterproof	CMR-W reticle Punisher impact tested and verified Fogproof and waterproof

# ADJUSTMENT DIAL GUIDE

Why doesn't every riflescope use the same dials? Because you need the right tool for the job.



### VX-3i LRP

Easy-to-grip, large external target dial that provides accurate and repeatable adjustments. Features a re-settable zero stop and a rotation indicator so you know how far you've dialed. Available in 1/4 MOA and 0.1 MIL.



### M5C2 ZeroLock Dials

Low-profile, two revolution dials that lock in the zero position to prevent inadvertent adjustments. Features aggressive knurling for a sure grip and fast, precise zeroing.



### M6C1 ZeroLock® Dials

Low-profile, ZeroLock® adjustments with tactile and audible .2 Mil per click and 11 milliradians of elevation travel in a single revolution.



### M5C3 ZeroLock Dials

Low-profile, .1 Mil per click dials provide 30-Mils of adjustment in 3 revolutions. Visual and tactile revolution indicators ensure you don't get lost in the travel. The ZeroLock feature prevents inadvertent adjustments and ensures accurate return to zero.



### M5B2/M5B1 Dials

Two revolution (one revolution on the M5B1 dial) Pinch and Turn dials autolock in every position to prevent inadvertent adjustments. Ensures accurate return to zero. Features aggressive knurling for a sure grip, and a visible, tactile revolution indicator.



### VX-Freedom AR Dial

External, low-profile 0.1 MIL dial with pre-calibrated .223 ballistics. Provides yardage marks out to 650 yards for easy mid-range engagements.

Scope	Elevation Adjustment Style	Elevation	Windage	Zero Stop/Revolutions	Travel/Revolution
VX-Freedom AR	Freedom AR Dial	1/10 Mil	1/10 Mil	No	6 Mil
VX-3i LRP	Zero Stop Target	.1 Mil 1/4 MOA	.1 Mil 1/4 MOA	Yes/3**	5 Mil 15 MOA
Mark 5HD (5-25x)	M5C3 ZeroLock	.1 Mil 1/4 MOA	.1 Mil 1/4 MOA	Yes/3**	10.5 Mil 25 MOA
Mark 5HD (3.6-18x)	M5C3 ZeroLock	.1 Mil 1/4 MOA	.1 Mil 1/4 MOA	Yes/3**	10.5 Mil 25 MOA
Mark 5HD (7-35)	M5C3 ZeroLock	.1 Mil 1/4 MOA	.1 Mil 1/4 MOA	Yes/3**	10.5 Mil 25 MOA
Mark 8 (1.1-8x) CQBSS	M5B1 Auto-Locking, Pinch and Turn	.1 Mil	.1 Mil	Yes	10 Mil
Mark 8 (3.5-25x) / Mark 6 (3-18x)	M5B2 Auto-Locking, Pinch and Turn	.1 Mil	.1 Mil	Yes/2*	10 Mil
Mark 8 (3.5-25x) / Mark 6 (3-18x)	M5C2 ZeroLock	.1 Mil	.1 Mil	Yes/2*	10 Mil
Mark 6 (1-6x)	M6C1 ZeroLock	.2 Mil	.2 Mil	Yes/1	11 Mil

\*20-Mils total with Tactile Revolution Indicator | \*\*30-Mils total with Tactile Revolution Indicator

# MARK 8



These are the riflescopes at the tip of the spear, first focal plane reticles, maximum resolution and field of view, 8:1 zoom range, and the image brightness and contrast necessary to triumph in the worst conditions. The Mark 8® 3.5-25x56 M5B2 Illuminated gives you seven brightness settings and auto-locking pinch and turn dials. The Mark 8 3.5-25x56 M5C2 offers the same magnification, with ZeroLock adjustments and a non-illuminated first focal plane reticle. The Mark 8 1.1-8x24 CQBSS® (Close Quarter Battle Sniper Scope) gives you precision at long-range and speed at arm's length. With each, you have best-of-the-best optical quality in a near indestructible package.

## KEY BENEFITS

### See more in less light with Twilight Max HD Light Management System

- Maximizes ambient light in extreme low-light environments
- Excellent glare management and virtually eliminates image wash-out caused by stray light
- Premium High Definition edge-to-edge lens clarity

**Offers more adjustment travel** with 34mm and 35mm maintubes

**Delivers accurate holdovers throughout the magnification range** with first focal plane reticles

**Provides precise and repeatable clicks** using the M5C2, M5B1, and M5B2 adjustments

**Engage targets at any distance** with a large 8x magnification range

**Extends battery life** with Motion Sensor Technology (MST)

**Disperses recoil energy for unrivaled durability** with ultra-lightweight construction

**Superior ruggedness** is verified through Leupold's Punisher testing process

**Waterproof, fogproof, and guaranteed to perform for life**

## MAGNIFICATION RANGES

1.1-8x24



3.5-25x56



# MARK 8

Mark 8	A	B	C	D	E	F	G	H	K	Obj. (mm)	Weight (oz)	Eye Relief Low/High (in)	FOV Low/High (ft @ 100 yd)	Elev. Adj. MOA	Wind Adj. MOA	Part Number	UPC Code
1.1-8x24 COBSS M5B1 Front Focal	12.0	6.6	2.0	3.5	3.6	1.6	1.4	1.7	34mm	24	23.5	3.7/3.3	92.0/17.7	175	175	<b>A</b> 112564	030317125646
																<b>B</b> 110121	030317101213
																<b>C</b> 114921	030317149215
																<b>D</b> 116670	030317166700
3.5-25x56 M5B2 Front Focal	16.0	5.3	1.7	1.7	4.7	6.0	2.7	1.7	35mm	56	32.5	3.1/3.7	32.0/4.7	90	50	<b>E</b> 115480	030317012984
																<b>F</b> 170812	030317015626
																<b>G</b> 170813	030317012991
																<b>H</b> 170814	030317013011
3.5-25x56 M5C2 Front Focal	16.0	6.4	1.7	2.8	3.3	6.0	2.7	1.7	35mm	56	32.5	3.1/3.7	32.0/4.7	90	50	<b>I</b> 171843	030317012984
																<b>J</b> 172732	030317015626
																<b>K</b> 171844	030317012991
																<b>L</b> 171845	030317013011

## SCOPE DIMENSIONS

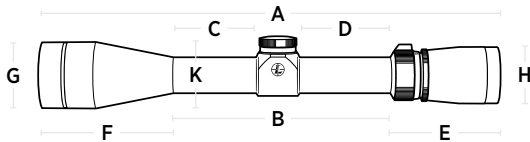

## KEY FEATURES

- Twilight Max HD Light Management System: Precise tracking and return to zero
- 8:1 zoom ratio: Lens covers
- 34mm and 35mm maintubes: Waterproof
- High-speed power selector: Fogproof
- M5B1, M5B2, or M5C2 locking adjustments: Guaranteed for life
- 10 Mills per turn with tactile revolution indicators

## AVAILABLE RETICLES

■ Illuminated Reticle

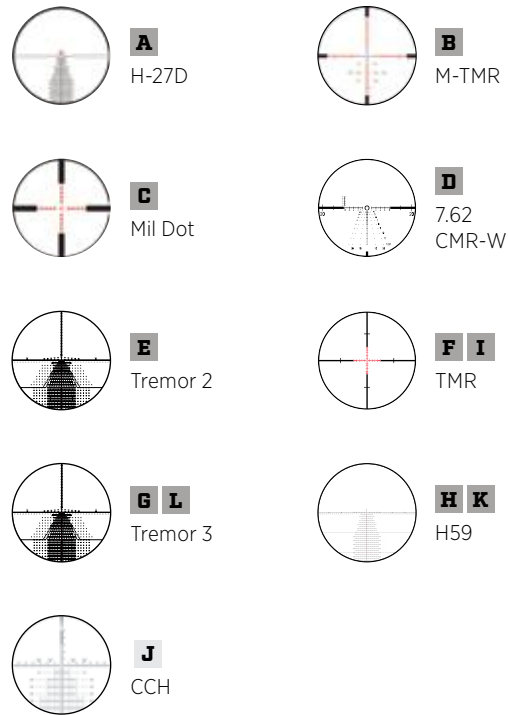

# MARK 6



The Leupold Mark 6® is extremely accurate, compact, lightweight, and easy to use; that's what makes it a game-changer for military forces around the globe and elite law enforcement units here at home. It's not just easy to manipulate, it's tough, too. Push it to the limit and a Mark 6 is still drop-dead accurate.

## KEY BENEFITS

### See more in less light with Twilight Max HD Light Management System

- Maximizes ambient light in extreme low-light environments
- Excellent glare management and virtually eliminates image wash-out caused by stray light
- Premium High Definition edge-to-edge lens clarity

**Provides up 37 Mils of adjustment travel** with a 34mm maintube

**Delivers accurate holdovers throughout the magnification range** with first focal plane reticles

**Engage targets at any distance** with a large 6x magnification range

**Offers easy access, water-tight battery compartment**

**Extends battery life** with Motion Sensor Technology (MST)

**Disperses recoil energy for unrivaled durability** with ultra-lightweight construction

**Superior ruggedness** is verified through Leupold's Punisher testing process

**Waterproof, fogproof, and guaranteed to perform for life**

## MAGNIFICATION RANGES

1-6x20



3-18x44



# MARK 6

Mark 6	A	B	C	D	E	F	G	H	K	Obj. (mm)	Weight (oz)	Eye Relief Low/High (in)	FOV Low/High (ft @ 100 yd)	Elev. Adj. MOA	Wind Adj. MOA	Part Number	UPC Code
1-6x20 M6C1 Front Focal	10.3	5.0	2.4	2.5	3.2	-	1.3	1.7	34mm	20	17.6	3.7/3.7	105.8/19.3	130	130	<b>A</b> 115044	030317150440
																<b>B</b> 114337	030317143374
																<b>C</b> 115045	030317150457
3-18x44 M5B2 Front Focal	11.9	5.9	1.8	2.5	3.2	2.7	2.1	1.7	34mm	44	23.6	3.8/3.9	36.8/6.3	90	50	<b>D</b> 115946	030317159467
																<b>I</b> 115943	030317159436
																<b>K</b> 119213	030317005269
3-18x44 M5C2 Front Focal	11.9	5.9	1.8	2.5	3.2	2.7	2.1	1.7	34mm	44	23.6	3.8/3.9	36.8/6.3	90	50	<b>J</b> 117876	030317002497
																<b>K</b> 120721	030317007621
																<b>F</b> 119214	030317005238
																<b>E</b> 115294	030317159245
																<b>I</b> 170826	030317010683
																<b>L</b> 170312	030317008345
<b>G</b> 170313	030317008352																

## SCOPE DIMENSIONS

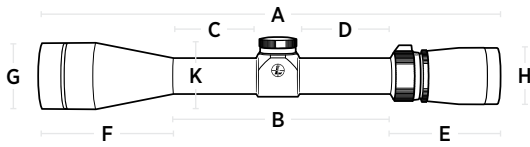

## KEY FEATURES

- Twilight Max HD Light Management System
- 6:1 zoom ratio
- 34mm maintube
- High-speed power selector
- M5C1, M5C2 or M5B2 locking adjustments
- 10 Mils per turn with tactile revolution indicators
- Precise tracking and return to zero
- Waterproof
- Fogproof
- Guaranteed for life

## AVAILABLE RETICLES

■ Illuminated Reticle

	<b>A</b> CMR-W 5.56		<b>B</b> CMR-W 7.62
	<b>C</b> TMR-D		<b>D</b> Mil-Dot
	<b>E J</b> Tremor 2		<b>I F</b> TMR
	<b>G L</b> Tremor 3		<b>K</b> H59



# MARK 5HD



Pick up a Mark 5HD™ and you'll feel the difference: it's up to 20 ounces lighter than other scopes in its class. Get behind one and you'll see the difference, from the superior edge-to-edge clarity and extreme low-light performance to the versatility of the Combat Competition Hunter reticle. With three revolutions of elevation adjustment, the Mark 5HD was built to max out the performance of the latest long range rifles and ammunition. Ergonomically designed with more tactile, audible click adjustments, larger numbers, and a high-speed throw lever so you can put accurate fire downrange faster.

## KEY BENEFITS

### See more in less light with Twilight Max HD Light Management System

- Maximizes ambient light in extreme low-light environments
- Excellent glare management and virtually eliminates image wash-out caused by stray light
- Premium High Definition edge-to-edge lens clarity

**Provides accurate holdovers throughout the magnification range** with first focal plane reticles

**Engage targets at any distance** with a large 5x magnification range

**Extends long-range shooting** with a lightweight 35mm maintube

**Delivers 120 MOA or 34.9 MILs of travel** using a precise and repeatable 3-turn ZeroLock dial

**Improves magnification changes** with an integrated throw lever

**Disperses recoil energy for unrivaled durability** with ultra-lightweight construction

**Superior ruggedness** is verified through Leupold's Punisher testing process

**Waterproof, fogproof, and guaranteed to perform for life**

## MAGNIFICATION RANGES

3.6-18x44



5-25x56



7-35x56



# MARK 5HD

TACTICAL SCOPES

Mark 5HD	A	B	C	D	E	F	G	H	K	Obj. (mm)	Weight (oz)	Eye Relief Low/High (in)	FOV Low/High (ft @ 100 yd)	Elev. Adj. MOA	Wind Adj. MOA	Part Number	UPC Code
3.6-18x44 M5C3 Front Focal	12.1	5.9	1.7	2.0	3.3	2.9	2.1	1.8	35mm	44	26.0	3.5/3.8	28.3/5.8	100.0	80	<b>A</b> 173296	030317016357
																<b>B</b> 173297	030317016371
																<b>C</b> 173298	030317016388
																<b>D</b> 173299	030317016364
																<b>E</b> 173301	030317016395
																<b>H</b> 176445	030317021108
																<b>I</b> 176446	030317021115
																<b>J</b> 176447	030317021078
																<b>F</b> 176811	030317021627
																5-25x56 M5C3 Front Focal	15.7
<b>B</b> 171773	030317012939																
<b>C</b> 171774	030317012960																
<b>D</b> 171775	030317012922																
<b>E</b> 171776	030317012946																
<b>F</b> 171777	030317012953																
<b>H</b> 176448	030317021122																
<b>I</b> 176449	030317021085																
<b>J</b> 176450	030317021092																
7-35x56 M5C3 Front Focal	15.7	6.2	2.0	2.0	3.3	6.2	2.5	1.8	35mm	56	33.0	3.6/3.8	14.7/ 3.0	100.0	50		
																<b>B</b> 174546	030317018405
																<b>J</b> 174548	030317018382
																<b>E</b> 176124	030317020842
																<b>A</b> 176594	030317021313
7-35x56 MIC3 Rear Focal	15.7	6.2	2.0	2.0	3.3	6.2	2.5	1.8	35mm	56	33.0	3.6/3.8	14.7/ 3.0	100.0	50	<b>D</b> 177332	030317022648
																<b>F</b> 177333	030317022631
																<b>K</b> 174549	030317018399

## SCOPE DIMENSIONS

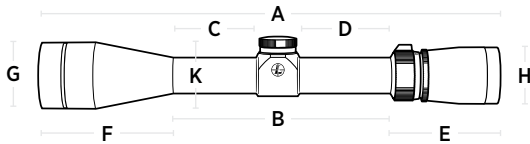

## KEY FEATURES

Twilight Max HD Light Management System	3-turn dial, 10.5 MILs per turn with tactile revolution indicators
5:1 zoom ratio	Precise tracking and return to zero
35mm maintube	
Ultra-lightweight design	Motion Sensor Technology (MST)
High-speed power selector	Lens shade
Integrated throw lever	Lens covers
M5C3 ZeroLock adjustments	Waterproof
	Fogproof
MIL or MOA adjustments/reticles	Guaranteed for life

## AVAILABLE RETICLES

■ Illuminated Reticle

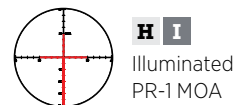
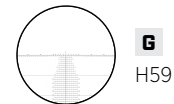
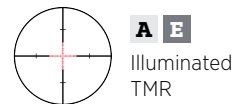

# VX-3i LRP



The name says it all – Long Range Precision (LRP). This scope is purpose built with match-grade accuracy and repeatability. Choose between first or second focal planes, MOA or MIL adjustments, and several magnification options. With easy-to-read adjustment dials and integrated quick-turn throw lever, the VX-3i LRP will help you push your limits. Top that off with Leupold's Twilight Max Light Management System, and you'll be hitting steel from dawn to dusk.

## KEY BENEFITS

### See more in less light with Twilight Max Light Management System

- Intensifies ambient light in low-light environments
- Great glare management and drastically reduces image wash-out caused by stray light
- Premium edge-to-edge lens clarity

**Provides worry-free and repeatable elevation adjustments** with a zero-stop and revolution indicator

**Offers MIL and MOA models** for every shooting preference

**First and second focal plane models are available**

**Creates more adjustment travel** for longer shots with a 30mm maintube

**Quickly change the magnification** using the integrated throw-lever

**Disperses recoil energy for unrivaled durability** with ultra-lightweight construction

**Superior ruggedness** is verified through Leupold's Punisher testing process

**Waterproof, fogproof, and guaranteed to perform for life**

## MAGNIFICATION RANGES

6.5-20x50



8.5-25x50



# VX-3i LRP

VX-3i LRP	A	B	C	D	E	F	G	H	K	Obj. (mm)	Weight (oz)	Eye Relief Low/High (in)	FOV Low/High (ft @ 100 yd)	Elev. Adj. MOA	Wind Adj. MOA	Part Number	UPC Code
6.5-20x50 Side Focus Target	14.6	6.5	2.6	2.4	3.2	4.8	2.3	1.6	30mm	50	21.7	4.1/3.2	14.7/6.1	80	80	<b>A</b> 172340	030317013745
																<b>B</b> 172342	030317013714
																<b>D</b> 172341	030317013820
6.5-20x50 Side Focus Front Focal Target	14.6	6.5	2.6	2.4	3.2	5.0	2.3	1.6	30mm	50	21.7	4.1/3.2	14.1/5.8	80	80	<b>B</b> 172343	030317013721
																<b>C</b> 172344	030317013806
																<b>F</b> 174509	030317018368
8.5-25x50 Side Focus Target	14.6	6.5	2.6	2.4	3.2	4.8	2.3	1.6	30mm	50	22.4	5.3/3.7	11.5/4.6	80	80	<b>A</b> 172345	030317013752
																<b>B</b> 172346	030317013783
8.5-25x50 Side Focus Front Focal Target	14.6	6.5	2.6	2.4	3.2	5.0	2.3	1.6	30mm	50	22.4	5.3/3.7	11.5/4.6	80	80	<b>B</b> 172347	030317013813
																<b>C</b> 179069	030317025229

## SCOPE DIMENSIONS

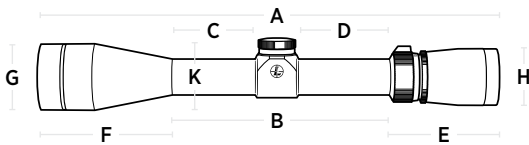

## KEY FEATURES

- Twilight Max Light Management System
- 3:1 zoom ratio
- 30mm maintube
- Ultra-lightweight design
- High-speed power selector
- Integrated throw lever
- MIL or MOA adjustments/reticles
- Precise tracking and return to zero
- Waterproof
- Fogproof
- Guaranteed for life

## AVAILABLE RETICLES

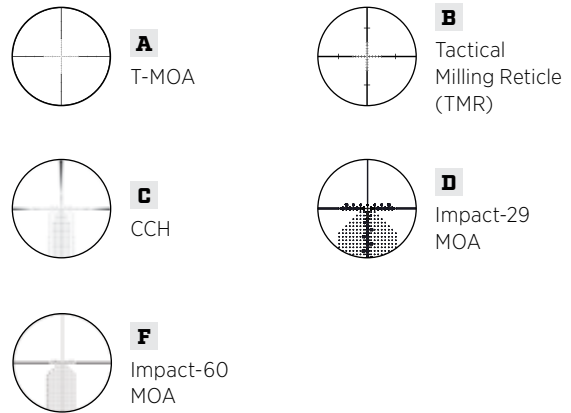

# VX-FREEDOM AR



The right tool for the job means choosing the right optic to get the most out of your gun. The VX-Freedom AR builds on the award winning line by giving shooters the features they need. MIL adjustments, exposed dials, and MIL reticles. All at a price that will let you start your next build sooner rather than later.

## KEY BENEFITS

### See more in less light with Twilight Max Light Management System

- Intensifies ambient light in low-light environments
- Great glare management and drastically reduces image wash-out caused by stray light
- Premium edge-to-edge lens clarity

### Eliminates holdovers on longer shots with the optional Custom Dial System

### Quickly change magnifications using the easy-to-grip power selector

### Disperses recoil energy for unrivaled durability with ultra-lightweight construction

### Superior ruggedness is verified through Leupold's Punisher testing process

### Creates a visible aiming point in any light condition with FireDot illumination

### Increases adjustment for longer shots with a 30mm maintube

### Extends battery life with Motion Sensor Technology (MST)

### Waterproof, fogproof, and guaranteed to perform for life

## MAGNIFICATION RANGES

1.5-4x20



1.5-4x20  
30mm



3-9x40



3-9x40  
30mm



4-12x40



4-12x40  
30mm



6-18x40  
30mm



# VX-FREEDOM AR

VX-Freedom	A	B	C	D	E	F	G	H	K	Obj. (mm)	Weight (oz)	Eye Relief Low/High (in)	FOV Low/High (ft @ 100 yd)	Elev. Adj. MOA	Wind Adj. MOA	Part Number	UPC Code
1.5-4x20	9.4	5.4	2.2	1.9	3.5	0.5	1.4	1.6	1.0	20	9.6	4.2/3.7	74.2/29.4	125	125	<b>A</b> 175073	030317019006
1.5-4x20 FireDot 223	9.4	5.4	2.2	1.9	3.5	0.5	1.4	1.6	30mm	20	9.6	4.2/3.7	74.2/29.4	125	125	<b>D</b> 177226	030317022471
3-9x40 FireDot	12.4	5.6	2.5	1.9	3.4	3.3	1.8	1.6	30mm	40	15.4	4.2/3.7	33.7/13.6	52	52	<b>C</b> 175077	030317019037
3-9x40 223	12.4	5.6	2.5	1.9	3.4	3.3	1.8	1.6	1.0	40	15.4	4.2/3.7	33.7/13.6	52	52	<b>B</b> 178252	030317024284
4-12x40 223	12.2	5.2	1.9	2.1	3.2	3.7	1.8	1.6	1.0	40	13.1	4.9/3.7	21.5/10.0	80	80	<b>B</b> 178254	030317024277
4-12x40 223 Side Focus	12.2	5.2	1.9	2.1	3.2	3.7	1.8	1.6	30mm	40	13.1	4.9/3.7	21.5/10.0	80	80	<b>B</b> 177230	030317022501
6-18x40 223 Side Focus	14.3	6.6	3.5	1.9	3.4	3.4	1.8	1.6	30mm	40	17	5.1/3.8	13.1/6.8	56	58	<b>B</b> 177231	030317022488

## SCOPE DIMENSIONS

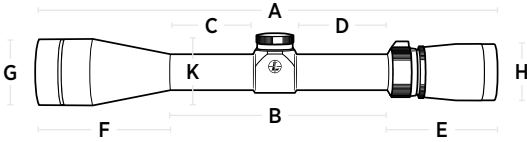

## KEY FEATURES

- Twilight Light Management System
- 3:1 zoom ratio
- 1-inch and 30mm maintubes
- Locking eyepiece (1 inch maintube models)
- Fast-focus eyepiece (30mm maintube models)
- Scratch-resistant lenses
- Available Finger Click adjustments
- Available .223 Freedom AR dial
- High-contrast MIL adjustment markings
- Ergonomic power selector
- Precision side focus adjustment available
- Available FireDot Illumination
- Available push-button illumination
- Available Motion Sensor Technology
- Ultra-lightweight design
- Waterproof
- Fogproof
- Guaranteed for life

## AVAILABLE RETICLES

■ Illuminated Model

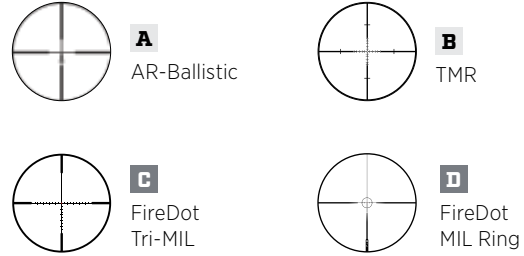

# D-EVO



If we told you that you can see your 1x red dot image and a 6x magnified image at the same time, you might think we were crazy. But crazy ideas often lead to ground-breaking technologies. Mount the Leupold Dual-Enhanced View Optic (D-EVO™) in front of virtually any compact red dot sight and instantly maximize the range of your AR style rifle. The D-EVO's unique design lets you move between your 1x red dot sight and the 6x magnification D-EVO by simply shifting your eye—not your head. Now you can quickly move between close-quarter shots and mid-range shots with deadly speed and accuracy. Whether your target materializes at 20 yards or 600 yards, you'll be ready to engage. It's not magic, it's the future of carbine optics.

## KEY BENEFITS

### See more in less light with Twilight Max Light Management System

- Intensifies ambient light in low-light environments
- Great glare management and drastically reduces image wash-out caused by stray light
- Premium edge-to-edge lens clarity

**Maximizes the rifle's effective distance** with 6x magnification

**Minimizes the amount of rail space needed** with a compact design

**Pairs perfectly with a large number of red dot sights** thanks to low-profile design

**Provides holdovers while compensating for lateral offset** with exclusive CMR-W reticle

**Disperses recoil energy for unrivaled durability** with ultra-lightweight construction

**Superior ruggedness** is verified through Leupold's Punisher testing process

**Waterproof, fogproof, and guaranteed to perform for life**



# D-EVO

D-EVO	Length	Height	Obj. (mm)	Weight (oz)	Eye Relief (in)	FOV (ft @ 100 yd)	Elev. Adj. MOA	Wind Adj. MOA	Part Number	UPC Code
6x20	4.6	2.0	20	13.8	3.4	15.7	50	50	120322	030317006716

## KEY FEATURES

Twilight Max Light Management System

6x magnification

.1-MIL click adjustments

Compact design

Waterproof

Fogproof

Guaranteed for life





## RETICLE



D-EVO  
CMR-W



# COMPARISON CHART

 Product	VX-4.5HD	FX-4.5HD	VX-67-42	Competition 45x45
Light Management System	 Twilight Max HD	 Twilight Max HD	 Twilight Max	 Twilight Max
Zoom Ratio	Fixed	Fixed	6:1	Fixed
Dial System	CDS-ZL2 1/4 MOA	CDS-ZL2 1/4 MOA	Target 1/8 MOA	Target 1/8 MOA
Magnification	1-4.5	4.5	7-42	45
Main Tube Size	30mm	30mm	34mm	30mm
Extra Features	New ector spring design Ultra-lightweight HPR-1 reticle	New ector spring design Ultra-lightweight HPR-1 reticle	Scratch resistant lenses Ultra-lightweight Fast focus eyepiece	Precision side focus adjustment Ultra-lightweight Precise 1/8 MOA Target Dot Reticle



# COMPETITION SERIES

VX-4.5HD SERVICE RIFLE 1-4.5x24



See better. Shoot better. Score better. The VX-4.5HD Service Rifle scope gives you the edge you need to win more matches. It delivers bright, edge-to-edge image sharpness at 4.5x magnification - the highest magnification allowed for NRA Service Rifle competitions. On its low power, the true 1x magnification's flat, true-to-life image makes off hand shooting quick and easy. Combine that with our new Bull-Ring reticles, developed in partnership with many of the top Service Rifle competitors, and you'll be able to quickly center on the target every time.

## KEY BENEFITS

### See more in less light with Twilight Max HD Light Management System

- Maximizes ambient light in extreme low-light environments
- Excellent glare management and virtually eliminates image wash-out caused by stray light
- Premium High Definition edge-to-edge lens clarity

**Increases adjustment travel for longer shots** with a 30mm maintube

**Leverages the NRA Service Rifle Competition specific magnification range**

**Finds targets easily** with an incredibly wide field-of-view

**Extends battery life** with Motion Sensor Technology (MST)

**Aligns targets easier** with the Bull-ring Post and FireDot Bull-ring reticles

**Eliminates holdovers on mid-range shots** with the Two-Turn ZeroLock (CDS-ZL2) adjustment

**Disperses recoil energy for unrivaled durability** with ultra-lightweight construction

**Superior ruggedness** is verified through Leupold's Punisher testing process

**Waterproof, fogproof, and guaranteed to perform for life**



# COMPETITION SERIES

## VX-4.5HD SERVICE RIFLE 1-4.5x24

Service Rifle	A	B	C	D	E	F	G	H	K	Obj. (mm)	Weight (oz)	Eye Relief Low/High (in)	FOV Low/High (ft @ 100 yd)	Elev. Adj. MOA	Wind Adj. MOA	Part Number	UPC Code
VX-4.5HD 1-4.5x24 CDS-ZL2	10.8	6.8	2.9	2.6	3.3	-	1.2	1.8	30mm	24	13.4	3.7/3.8	123.2/26.2	170	170	<b>A</b> 176281	030317020880
																<b>B</b> 176283	030317020903

### SCOPE DIMENSIONS

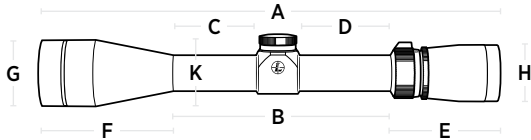

### KEY FEATURES

Twilight Max HD Light Management System	Motion Sensor Technology (MST)
4.5:1 zoom ratio	Available FireDot illumination
30mm maintube	Push-button illumination
CDS-ZL2 adjustments	Ultra-lightweight design
NRA Service Rifle specific reticle	Waterproof
Precise MOA adjustments	Fogproof

### AVAILABLE RETICLES

■ Illuminated Reticle

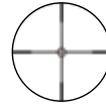

**A**  
FireDot  
Bull-Ring

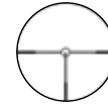

**B**  
Bull-Ring  
Post

# COMPETITION SERIES

**FX-4.5HD SERVICE RIFLE 4.5x24**



Service Rifle Competitions have gained a ton of popularity over the last few years. Along with the growth of the sport the level of gear has increased as well. Performance is paramount when tenths of an inch can mean the difference between 1st and 10th place. That's where Leupold's new Service Rifle FX-4.5HD scope comes in. The fixed 4.5x magnification ensures you'll always be at the right magnification, and the CDS-ZL2 elevation dial makes quick adjustments simple and precise. Leupold's new HPR-1 reticle makes finding and bracketing targets simple, and its fine center aiming-point gives you the ability to put rounds where your competition can't. The FX-4.5HD was made to get you on the podium.

## KEY BENEFITS

### See more in less light with Twilight Max HD Light Management System

- Maximizes ambient light in extreme low-light environments
- Excellent glare management and virtually eliminates image wash-out caused by stray light
- Premium High Definition edge-to-edge lens clarity

**Increases adjustment travel for longer shots** with a 30mm maintube

**Leverages the NRA Service Rifle Competition specific magnification range**

**Finds targets easily** with an incredibly wide field-of-view

**Aligns targets easier** with the HPR-1 reticle

**Eliminates holdovers on mid-range shots** with the Two-Turn ZeroLock (CDS-ZL2) adjustment

**Disperses recoil energy for unrivaled durability** with ultra-lightweight construction

**Superior ruggedness** is verified through Leupold's Punisher testing process

**Waterproof, fogproof, and guaranteed to perform for life**



# COMPETITION SERIES

## FX-4.5HD SERVICE RIFLE 4.5x24

Service Rifle	A	B	C	D	E	F	G	H	K	Obj. (mm)	Weight (oz)	Eye Relief (in)	FOV (ft @ 100 yd)	Elev. Adj. MOA	Wind Adj. MOA	Part Number	UPC Code
FX-4.5HD 4.5x24 CDS-ZL2	10.5	6.79	2.87	2.59	2.86	0.68	1.18	1.50	30mm	24	13.25	3.15	24.6	130	100	A 176284	030317020910

### SCOPE DIMENSIONS

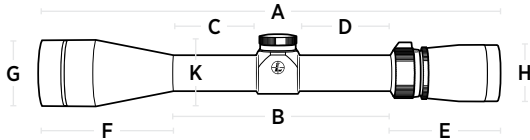

### AVAILABLE RETICLES



### KEY FEATURES

- Twilight Max HD Light Management System
- Precise MOA adjustments
- 4.5x Fixed power
- Ultra-lightweight design
- 30mm maintube
- Waterproof
- CDS-ZL2 adjustments
- Fogproof
- HPR-1 reticle

# COMPETITION SERIES

VX-6 7-42x56



Developed and tested alongside F-Class shooters, the 7-42x56mm delivers incredible precision at extreme distances. With the widest field-of-view among competitive scopes and the TMOA Plus reticle, featuring an open center, this scope helps shooters easily locate and engage targets when shots start stretching out to incredible distances.

## KEY BENEFITS

### See more in less light with Twilight Max Light Management System

- Intensifies ambient light in low-light environments
- Great glare management and drastically reduces image wash-out caused by stray light
- Premium edge-to-edge lens clarity

**Increases adjustment travel for longer shots** with a 34mm maintube

**Improves positive target and impact identification** with a high-powered 7-42x magnification range

**Finds targets easily** with an incredibly wide field-of-view

**Aligns targets easier** with the TMOA Plus reticle

**Improves repeatability** with precise, positive long-range specific adjustments

**Disperses recoil energy for unrivaled durability** with ultra-lightweight construction

**Superior ruggedness** is verified through Leupold's Punisher testing process

**Waterproof, fogproof, and guaranteed to perform for life**



# COMPETITION SERIES

VX-6 7-42x56mm

VX-6	A	B	C	D	E	F	G	H	K	Obj. (mm)	Weight (oz)	Eye Relief Low/High (in)	FOV Low/High (ft @ 100 yd)	Elev. Adj. MOA	Wind Adj. MOA	Part Number	UPC Code
7-42x56 Target	15.5	6.9	2.8	2.6	3.3	5.4	2.5	1.8	34mm	56	26.3	4.2/3.9	16.3/2.7	65	65	118504	030317004101

## SCOPE DIMENSIONS

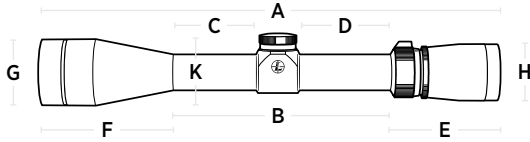

## RETICLE

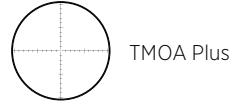

## KEY FEATURES

Twilight Max Light Management System	Precise MOA adjustments
6:1 zoom ratio	Ultra-lightweight design
34mm maintube	Waterproof
Target adjustments	Fogproof
TMOA Plus reticle	Guaranteed for life



# COMPETITION SERIES

45x45



When it all comes down to the slightest details, the Leupold Competition 45x45mm scope is the right tool for the job. Its high-powered magnification, precise tracking, and crystal-clear image gives you the advantage you need to leave the rest of the competition behind.

## KEY BENEFITS

### See more in less light with Twilight Max Light Management System

- Intensifies ambient light in low-light environments
- Great glare management and drastically reduces image wash-out caused by stray light
- Premium edge-to-edge lens clarity

**Increases adjustment travel for longer shots** with a 30mm maintube

**Improves positive target and impact identification** with a high-powered 45x magnification

**Simplifies use** with the fixed-power optical design

**Improves repeatability** with precise, positive long-range specific adjustments

**Disperses recoil energy for unrivaled durability** with ultra-lightweight construction

**Superior ruggedness** is verified through Leupold's Punisher testing process

**Waterproof, fogproof, and guaranteed to perform for life**



# COMPETITION SERIES

45x45mm

Competition Series	A	B	C	D	E	F	G	H	K	Obj. (mm)	Weight (oz)	Eye Relief (in)	FOV (ft @ 100 yd)	Elev. Adj. MOA	Wind Adj. MOA	Part Number	UPC Code
45x45 Target	15.9	7.1	3.2	2.5	2.4	6.1	2.2	1.6	30mm	45	20.4	3.2	2.5	40	40	53440	030317534400

## SCOPE DIMENSIONS

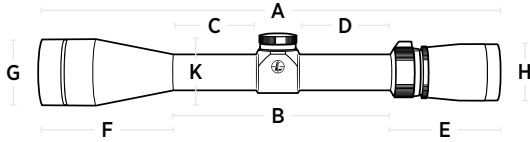



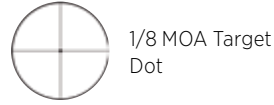

## RETICLE



## KEY FEATURES

- Twilight Max Light Management System
- Precise MOA adjustments
- Fixed 45x magnification
- Ultra-lightweight design
- 30mm maintube
- Waterproof
- Target adjustments
- Fogproof
- 1/8 MOA Target Dot
- Guaranteed for life

# COMPARISON CHART

Product	LC0	Datapoint Pro	Freedom BDS
			
Light Management System	Twilight Max Red Dot	Twilight Max Red Dot	Twilight Red Dot
Zoom Ratio	N/A	N/A	N/A
Dial System	Slotted 1/2-MOA click	Slotted 1-MOA click	1/4-MOA Click BDC Available
Magnification	1x	1x	1x
Main Tube Size	N/A	N/A	34mm
Extra features	16 brightness settings Waterproof to a 66-foot depth Up to 5-year battery life	Optional rear sight Motion Sensor Technology Waterproof to a 33-foot depth	AR-height mount Motion Sensor Technology



# LCO



When tunnel vision kicks in, the LCO® gives you an edge. Battlefield-of-view keeps your peripheral vision free of knobs, dials, or the scope housing, which can mask targets. The LCO's bold, crisp 1-MOA dot stands out in blinding sun or heavy rain, and you can quickly adjust between 16 brightness settings to match your conditions. The LCO is waterproof to 66 feet and can take a beating thanks to its aircraft-grade aluminum housing.

## KEY BENEFITS

### See more in less light with Twilight Max Red Dot System

- True-to-life color consistency
- Premium edge-to-edge lens clarity

**Improves target acquisition** with its huge field-of-view

**Eliminates distortion and color inconsistency** with crystal-clear lenses

**Offers 16 brightness settings** for any situation, including night vision

**Extends battery life** with Motion Sensor Technology (MST)

**Stands up to the roughest conditions** with scratch-resistant lenses

**Disperses recoil energy for unrivaled durability** with ultra-lightweight construction

**Superior ruggedness** is verified through Leupold's Punisher testing process

**Waterproof, fogproof, and guaranteed to perform for life**



# LCO

LCO	Length	Height	Obj. (mm)	Weight (oz)	Eye Relief (in)	FOV (ft @ 100 yd)	Elev. Adj. MOA	Wind Adj. MOA	Part Number	UPC Code
1x	3.6	2.4	-	9.5	Unlimited	-	60	60	119691	030317006365

## KEY FEATURES

- Twilight Max Red Dot System
- 1/2 MOA click adjustment
- Push-button on/off
- Integrated brightness controls
- CR123A 3v lithium battery
- Compact design
- 6061-T6 aircraft quality aluminum
- Waterproof
- Fogproof
- Guaranteed for life

## RETICLE



# DELTAPOINT PRO



The DeltaPoint Pro is proof that you don't have to compromise performance, even on a small sight. Its incredibly wide field-of-view and crystal-clear glass dominates the competition, while its rugged aluminum housing and spring steel guard ensure it will perform in the harshest conditions. Ease-of-use was also a focus when designing this elite red dot sight, which is why we put an easy access battery compartment on top and gave it click-adjustments for more precision. And this isn't just a pistol sight either; the DP Pro is just at home on AR's, shotguns, and pretty much anything else that goes bang.

## KEY BENEFITS

### See more in less light with Twilight Max Red Dot System

- True-to-life color consistency
- Premium edge-to-edge lens clarity

**Improves battery access without removing the sight** with top-side battery compartment

**Extends battery life** with Motion Sensor Technology (MST)

**Delivers quick, precise, and repeatable adjustments** with 1 MOA click-adjustments

**Improves target acquisition** with its huge field-of-view

**Eliminates distortion and color inconsistency** with crystal-clear lenses

**Stands up to the roughest conditions** with scratch-resistant lenses

**Disperses recoil energy for unrivaled durability** with ultra-lightweight construction

**Superior ruggedness** is verified through Leupold's Punisher testing process

**Waterproof, fogproof, and guaranteed to perform for life**



# DELTAPOINT PRO

DeltaPoint Pro	Length	Height	Obj. (mm)	Weight (oz)	Eye Relief Low/High (in)	FOV Low/High (ft @ 100 yd)	Elev. Adj. MOA	Wind Adj. MOA	Part Number	UPC Code
1x	1.8	1.3	-	2.0	-	-	60	60	A 119688	030317005856
1x with AR Mount	1.8	1.3	-	2.0	-	-	60	60	A 177156	030317022310
1x Dark Earth	1.8	1.3	-	2.0	-	-	60	60	A 175840	030317020460

## KEY FEATURES

- Twilight Max Red Dot System: Lightweight aluminum housing
- 1 MOA slotted click adjustment: Optional integrated rear sight
- Push-button on/off: Waterproof
- Tool-less quick-change battery compartment: Fogproof
- Motion Sensor Technology (MST): Guaranteed for life
- Compact design

## AVAILABLE RETICLES

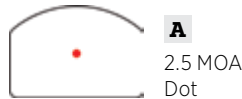

DeltaPoint Pro AR Mount	Part Number	UPC Code
DeltaPoint Pro AR Mount	177154	030317022358
DeltaPoint Pro Cross Slot Mount Matte	120056	030317006266
DeltaPoint Pro Cross Slot Riser Matte	120059	030317006273
DeltaPoint Pro Rear Iron Sight Matte	120058	030317006280
DeltaPoint Pro Dovetail Mount, Beretta 92 Matte	170902	030317011147
DeltaPoint Pro Dovetail Mount, CZ 75 Matte	170903	030317011239
DeltaPoint Pro Dovetail Mount, 1911 Matte	170904	030317011154
DeltaPoint Pro Dovetail Mount, Ruger American .45 Matte	172783	030317015664
DeltaPoint Pro Dovetail Mount, Ruger American 9mm Matte	172784	030317015657
DeltaPoint Pro Mount, Marlin 336 Matte	172645	030317015077
DeltaPoint Pro Dovetail Mount, HK Matte	170905	030317011192
DeltaPoint Pro Dovetail Mount, Glock Matte	170906	030317011130
DeltaPoint Pro Dovetail Mount, SIG 226 Matte	170908	030317011178
DeltaPoint Pro Dovetail Mount, SW MP Matte	170909	030317011185
DeltaPoint Pro Dovetail Mount, Springfield Matte	170910	030317011208
DeltaPoint Pro Mount, SW Classic Matte	170911	030317011215
DeltaPoint Pro Mount, SW MP CORE Matte	171203	030317011734
DeltaPoint Pro AR DLOC Mount, Matte	171861	030317013035
DeltaPoint Pro 45° AR Mount	173236	030317016272
DeltaPoint Pro 1" Ring Top Mount Kit	175541	030317019907
DeltaPoint Pro 30mm Ring Top Mount Kit	175550	030317019914
DeltaPoint Pro 34mm Ring Top Mount Kit	175554	030317019884
DeltaPoint Pro 35mm Ring Top Mount Kit	175558	030317019891

\*Compatible with Leupold Mark 4 Rings and IMS Mounts. (Not Compatible with Mark 2 IMS)



# FREEDOM RDS



All red dots are not created equal. The Freedom RDS (red dot sight) changes the game when it comes to consistency and durability in a red dot sight. We took our 70+ years of optics knowledge and created a red dot that's built Leupold tough, performs in extreme conditions, and won't break the bank. It's everything you need in a red dot and nothing you don't.

## KEY BENEFITS

### See more in less light with Twilight Red Dot System

- Standard color consistency
- Premium lens clarity

Delivers a clear and precise aiming point with 1-MOA dot

Extends battery life with Motion Sensor Technology (MST)

Offers precise 1/4-MOA click adjustments

Installs easily with AR height mount

Provides accurate mid-range engagements with pre-calibrated 223 Rem BDC dial

Superior ruggedness by Punisher testing and verification

Disperses recoil energy for unrivaled durability with ultra-lightweight construction

Waterproof, fogproof, and guaranteed to perform for life



# FREEDOM RDS

Freedom RDS	Length	Maintube	Obj. (mm)	Weight (oz)	Eye Relief Low/High (in)	Elev. Adj. MOA	Wind Adj. MOA	Part Number	UPC Code
1x34 w/ mount	5.3	34mm	34	6.9	Unlimited	80	80	174954	030317018955
1x34 w/ mount								176533 - BDC	030317021276
1x34	5.3	34m	34	6.9	Unlimited	80	80	176204	030317020859







## KEY FEATURES

- Twilight Red Dot System      Motion Sensor Technology (MST)
- True 1x magnification          AR-height mount
- 34mm maintube                  Waterproof
- Scratch-resistant lenses       Fogproof
- 1/4-MOA click adjustments    Guaranteed for life
- Push button illumination

## RETICLE



# COMPARISON CHART

	 LEUPOLD						
Product	BK-5 Summit HD		BK-4 Pro Guide HD	BK-1 HD	BK-2 Alpine	BK-1 McKenzie	BK-1 Rogue
Light Management System	Twilight Max HD	Twilight Max HD	Twilight Max HD	Twilight Max HD	Twilight Max	Twilight	Twilight
Magnification	8x, 10x, 12x, 15x	8x, 10x, 12x	10x	8x, 10x, 12x	8x, 10x, 12x	8x, 10x, 12x	8x, 10x
Objective Diameter	42mm, 50mm, 56mm	32mm, 42mm, 50mm	42mm	42mm, 52mm	42mm, 50mm	25mm	
Weight	23.4-45 oz	17-28.5 oz	17-28.5 oz	24.1-30.5 oz	22-28.5 oz	12.7 oz	
Length	5.6-8.2 in	4.8-6.6 in	5.6 in	5.0-5.4 in	5.8-6.7 in	4.3 in	
Type	Roof	Roof	Roof	Roof	Roof	Compact Porro	
Extra Features	Field replaceable eyecups Camo patterns available 100% fogproof and waterproof	Field replaceable eyecups Camo patterns available 100% fogproof and waterproof	Field replaceable eyecups MIL-L reticle available 100% fogproof and waterproof	Lightweight magnesium housing 100% fogproof and waterproof	High-impact polycarbonate housing 100% fogproof and waterproof	Small, compact design 100% fogproof and waterproof	



# BX-5 SANTIAM HD



Knowing your surroundings and being able to spot the tiniest details in tough lighting conditions can make or break your hunt. That's where our BX-5 Santiam HD comes in. Featuring our Twilight Max HD Light Management System, the BX-5 Santiam HD has unmatched low-light performance, while virtually eliminating glare. Its elite optical system also delivers edge-to-edge sharpness and contrast for comfortable all-day glassing, and its rugged, armor-coated, waterproof body is purpose built to take the abuse any backcountry adventure can dish out. The BX-5 Santiam HD truly redefines what a premium binocular should be.

## KEY BENEFITS

### See more in less light with Twilight Max HD Light Management System

- Maximizes ambient light in extreme low-light environments
- Excellent glare management and virtually eliminates image wash-out caused by stray light
- Premium High Definition edge-to-edge lens clarity

### Eliminates eye strain for all-day glassing comfort with a superior optical design

### Survives the toughest conditions with lightweight, high-impact body

### Offers easy maintenance with field-replaceable aluminum eyecups

### Delivers crystal-clear images with precision focus adjustments

### Provides comfortable hand placement with an open-bridge, dual-hinge design

### Mounts easily with 1/4-20 threaded tripod adapter

### Sheds dirt and water for clear, crisp images with Guard-ion lens coating

### Superior ruggedness is tested for extreme climates

### Waterproof, fogproof, and guaranteed to perform for life



# BX-5 SANTIAM HD

BX-5 Santiam HD	Actual Magnification	Obj. Aperture (mm)	Weight (oz)	Length (in)	Eye Relief (mm)	Linear FOV (ft @ 1000 yd)	Angular FOV	Interpupillary Distance	Part Number	UPC Code
8x42	8x	42	23.6	5.9	18.5	377	7.2	58-78	<b>A</b> 174481	030317018283
10x42	10x	42	24.3	5.9	16.6	341	6.5	58-74	<b>A</b> 174483	030317018313
									<b>B</b> 174484	030317018290
10x50	10x	50	31.5	6.8	19.3	304	5.8	58-74	<b>A</b> 175854	030317020507
12x50	12x	50	32.1	6.8	16.6	272	5.2	58-74	<b>A</b> 175856	030317020514
15x56	15x	56	45.0	8.2	18.0	231	4.4	58-74	<b>A</b> 172457	030317013981

## KEY FEATURES

- Twilight Max HD Light Management System  
1/4-20 threaded tripod adapter
- Open-bridge, dual-hinge design  
Premium case and strap included
- Generous eyepiece  
Bino tray included with 56mm model
- Guard-ion lens coating  
Waterproof
- Ultra-smooth focus adjustments  
Fogproof
- Lightweight design  
Guaranteed for life
- Field-replaceable aluminum eyecups

## AVAILABLE FINISHES



**A**  
Shadow Gray

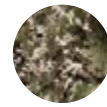

**B**  
GORE Optifade Subalpine

# BX-4 PRO GUIDE HD



The BX-4 Pro Guide HD binoculars are built around the Leupold Twilight Max HD Light Management System. The specialized lens coatings allow you to see more in less light and glass longer during the early predawn hours to well past dusk. The slim-hinge (32mm) or open bridge design and durable aluminum body is both comfortable to hold and lightweight enough for easy carrying. The textured body armor allows for a sure grip in any conditions, with or without gloves. Completely waterproof and backed by the Leupold Full Lifetime Guarantee, the BX-4 Pro Guide HD binoculars are a welcome addition for anyone who wants to see more outdoors.

## KEY BENEFITS

### See more in less light with Twilight Max HD Light Management System

- Maximizes ambient light in extreme low-light environments
- Excellent glare management and virtually eliminates image wash-out caused by stray light
- Premium High Definition edge-to-edge lens clarity

**Delivers incredible ruggedness** with a lightweight aluminum body

**Offers easy maintenance** with field-replaceable eyecups

**Provides comfortable hand placement** with an open-bridge, slim-hinge design

**Delivers crystal-clear images** with precision focus adjustments

**Mounts easily** with 1/4 - 20 threaded tripod adapter

**Sheds dirt and water for clear, crisp images** with Guard-ion lens coating

**Superior ruggedness** is tested for extreme climates

**Waterproof, fogproof, and guaranteed to perform for life**



# BX-4 PRO GUIDE HD

BX-4 Pro Guide HD	Actual Magnification	Obj. Aperture (mm)	Weight (oz)	Length (in)	Eye Relief (mm)	Linear FOV (ft @ 1000 yd)	Angular FOV	Interpupillary Distance	Part Number	UPC Code
8x32	8x	32	17.0	4.8	16.0	394	7.5	58-74	<b>A</b> 172658	030317015183
10x32	10x	32	17.0	4.8	16.0	394	7.5	58-74	<b>A</b> 172660	030317015084
8x42	8x	42	23.4	5.6	19.0	368	7.0	58-74	<b>A</b> 172662	030317015091
10x42	10x	42	24.0	5.6	16.0	326	6.2	58-74	<b>A</b> 172666	030317015312
									<b>B</b> 172669	030317015329
									<b>C</b> 172667	030317015107
10x50	10x	50	28.0	6.6	18.8	283	5.7	58-74	<b>A</b> 172670	030317015336
12x50	12x	50	28.5	6.6	16.0	251	4.8	58-74	<b>A</b> 172675	030317015343

## KEY FEATURES

- Twilight Light Max HD Management System      Field-replaceable aluminum eyecups
- Open-bridge, dual-hinge design      1/4-20 threaded tripod adapter
- Aluminum body      Premium case and strap
- Generous eyepiece      Waterproof
- Guard-ion lens coating      Fogproof
- Ultra-smooth focus adjustments      Guaranteed for life
- Lightweight design

## AVAILABLE FINISHES

- A** Shadow Gray
- B** SITKA Subalpine
- C** Kryptek Typhon Black



# BX-T HD TACTICAL



The BX-T HD tactical binocular is purpose built to give you the tactical advantage needed to succeed in any situation. Its ultra low-light performance combined with extreme climate tested body are ideal for field applications. The available Mil-L reticle also gives you measuring, rangefinding, and spotting capabilities. Complete your kit with the Leupold BX-T HD tactical binocular.

## KEY BENEFITS

### See more in less light with Twilight Max HD Light Management System

- Maximizes ambient light in extreme low-light environments
- Excellent glare management and virtually eliminates image wash-out caused by stray light
- Premium High Definition edge-to-edge lens clarity

**Delivers measuring, ranging, and spotting capabilities** with a tactical Mil-L reticle

**Provides comfortable hand placement** with open-bridge, dual-hinge design

**Offers easy maintenance** with field-replaceable aluminum eyecups

**Mounts easily** with 1/4 - 20 threaded tripod adapter

**Stays secure in all conditions** thanks to easy-grip rubber armor

**Delivers crystal-clear images** with precision focus adjustments

**Superior ruggedness** is tested for extreme climates

**Waterproof, fogproof, and guaranteed to perform for life**



# BX-T HD TACTICAL

BX-T HD Tactical	Actual Magnification	Obj. Aperture (mm)	Weight (oz)	Length (in)	Eye Relief (mm)	Linear FOV (ft @ 1000 yd)	Angular FOV	Interpupillary Distance	Part Number	UPC Code
10x42 Black	10x	42	24.0	5.6	16.0	326	6.2	58-74	A 176289	030317159351

## KEY FEATURES

- Twilight Light Max HD Management System
  - Open-bridge, dual-hinge design
  - Aluminum body
  - Generous eyebox
  - Guard-ion lens coating
  - Available Mil-L reticle
  - Ultra-smooth focus adjustments
- Lightweight design
  - Field-replaceable aluminum eyecups
  - 1/4-20 threaded tripod adapter
  - Berry Compliant MOLLE case and strap
  - Waterproof
  - Fogproof
  - Guaranteed for life

## RETICLE



# BX-2 ALPINE



Whether it's your first binocular or your 50th, your glass needs to give you a bright image, feel comfortable in your hands, and be able to take a beating. The BX-2 Alpine binocular checks all these boxes and more. With our Twilight Max Light Management System, this binocular will out-perform everything in its class when it comes to seeing more in less light. And backed by our Full Lifetime Guarantee, you'll be wondering why you didn't have to pay more.

## KEY BENEFITS

### See more in less light with Twilight Max Light Management System

- Intensifies ambient light in low-light environments
- Great glare management and drastically reduces image wash-out caused by stray light
- Premium edge-to-edge lens clarity

**Delivers incredible ruggedness** with a lightweight magnesium body

**Protects against the harshest conditions** using EXO-Armor

**Mounts easily** with 1/4 - 20 threaded tripod adapter

**Delivers crystal-clear images** with precision focus adjustments

**Superior ruggedness** is tested for extreme climates

**Waterproof, fogproof, and guaranteed to perform for life**



# BX-2 ALPINE

BX-2 Alpine	Actual Magnification	Obj. Aperture (mm)	Weight (oz)	Length (in)	Eye Relief (mm)	Linear FOV (ft @ 1000 yd)	Angular FOV	Interpupillary Distance	Part Number	UPC Code
8x42 Shadow Gray	8	42	24.3	5.0	18.0	387	7.4	57-78	176969	030317015251
10x42 Shadow Gray	10	42	24.1	5.0	15.0	342	6.5	57-78	176971	030317015589
10x52 Shadow Gray	10	52	30.5	5.4	18.0	279	5.9	60-78	176973	030317015268
12x52 Shadow Gray	12	52	30.3	5.4	15.0	261	5.0	60-78	176975	030317015152

## KEY FEATURES

Twilight Max Light Management System	1/4-20 threaded tripod adapter
Precision focus adjustments	Premium case and strap
Large eyepiece	Waterproof
EXO-armor housing	Fogproof
Lightweight magnesium body	Guaranteed for life

# BX-1 MCKENZIE



The Leupold BX-1 McKenzie binocular packs a surprising amount of features into a versatile package that anyone can use. Our proprietary Twilight Light Management System ensures outstanding performance in even the toughest lighting conditions. Find out why the McKenzie's outperform their price tag and competition.

## KEY BENEFITS

### See more in less light with Twilight Light Management System

- Amplifies ambient light in low-light environments
- Good glare management and minimizes image wash-out caused by stray light
- Premium lens clarity

**Maximizes durability** with high-impact polymer housing

**Stays secure in all conditions** thanks to easy-grip rubber armor

**Increases comfort** with twist-up eyecups

**Delivers crystal-clear images** with precision focus adjustments

**Superior ruggedness** is tested for extreme climates

**Waterproof, fogproof, and guaranteed to perform for life**



# BX-1 MCKENZIE

BX-1 McKenzie	Actual Magnification	Obj. Aperture (mm)	Weight (oz)	Length (in)	Eye Relief (mm)	Linear FOV (ft @ 1000 yd)	Angular FOV	Interpupillary Distance	Part Number	UPC Code
8x42 Shadow Gray	8	42	22.1	5.8	17.7	330	6.1	56-74	173787	030317017545
10x42 Shadow Gray	10	42	22.0	5.8	13.7	305	5.8	56-74	173788	030317017521
12x50 Shadow Gray	12	50	28.5	6.7	13.7	242	4.6	58-74	173790	030317017514

## KEY FEATURES

- Twilight Light Management System
- Central focus dial
- Diopter focus
- Twist-up eyecups
- Premium case and strap
- Waterproof
- Fogproof
- Guaranteed for life

# BX-1 ROGUE



BX-1 Rogue compacts are at home in the field, at the game, and everywhere people want to get close to the action. The Porro prism design delivers clarity and brightness that never disappoints.

## KEY BENEFITS

### See more in less light with Twilight Light Management System

- Amplifies ambient light in low-light environments
- Good glare management and minimizes image wash-out caused by stray light
- Premium lens clarity

**Maximizes durability** with an armor-coated housing

**Delivers crystal-clear images** with a center focus dial and diopter focus adjustment

**Waterproof, fogproof, and guaranteed to perform for life**



# BX-1 ROGUE

BX-1 Rogue	Actual Magnification	Obj. Aperture (mm)	Weight (oz)	Length (in)	Eye Relief (mm)	Linear FOV (ft @ 1000 yd)	Angular FOV	Interpupillary Distance	Part Number	UPC Code
8x25 Black	8	25	12.7	4.3	15	377	6.4	57-71	59220	030317592202
10x25 Black	10	25	12.7	4.3	15	294	5.6	57-71	59225	030317592257

## KEY FEATURES

- Twilight Light Management System
- 25mm objective
- Inverted porro prism design
- Easy-turn focus dial
- Diopter focus
- Armor coated
- Twist-up eyecups
- Storage case and strap
- Waterproof
- Fogproof
- Guaranteed for life



# LEUPOLD MARKSMAN

OFFERED EXCLUSIVELY THROUGH BASS PRO SHOPS/CABELA'S



Don't let the small price tag fool you, these binos are built for the hunt. The Twilight Light Management System delivers incredibly clear, detailed images to help you see more in tough lighting conditions where others fail. Backed by our Full Lifetime Guarantee, the Marksman 10x42 binos deliver a level of performance that will amaze you.

## KEY BENEFITS

### See more in less light with Twilight Light Management System

- Amplifies ambient light in low-light environments
- Good glare management and minimizes image wash-out caused by stray light
- Premium lens clarity

**Maximizes durability** with high-impact aluminum housing

**Stays secure in all conditions** thanks to easy-grip rubber armor

**Mounts easily** with 1/4 - 20 threaded tripod adapter

**Increases comfort** with twist-up eyecups

**Delivers crystal-clear images** with precision focus adjustment

**Superior ruggedness** is tested for extreme climates

**Waterproof, fogproof, and guaranteed to perform for life**



# LEUPOLD MARKSMAN

Leupold Marksman	Actual Magnification	Obj. Aperture (mm)	Weight (oz)	Length (in)	Eye Relief (mm)	Linear FOV (ft @ 1000 yd)	Angular FOV	Interpupillary Distance	Part Number	UPC Code
10x42 Black	10x	42	26.4	5.9	16.3	341	6.5	58-73	176771	030317021573

## KEY FEATURES

- Twilight Light Management System
- Compact design
- Easy-turn focus dial
- Easy-grip armor
- Twist-up eyecups
- Tripod adapter
- Storage case and strap
- Waterproof
- Fogproof
- Guaranteed for life

# COMPARISON CHART

					
Product	SX-5 Summit HD	SX-4 Pro Guide HD	Mark 4	Gold Ring	Gold Ring Compact
Light Management System	Twilight Max HD	Twilight Max HD	Twilight Max	Twilight Max and Twilight Max HD	Twilight
Magnification Options	27-55x80mm	15-45x65mm 20-60x85mm	12-40x60mm 20-60x80mm	12-40x60mm 20-60x80mm	10-20x40mm 15-30x50mm
Eyepiece Style	Straight and angled models	Straight and angled models	Straight	Straight	Straight
Weight (Low to High)	68.7 oz	62 oz 78.2 oz	37 oz 61.8 oz	37 oz 61.8 oz	15.8 oz 21.5 oz
Length (Low to High)	15.7 in 16.4 in	14.1 in 17.7 in	12.4 in 15.5 in	12.4 in 15.5 in	7.5 in 11 in
Reticles Available	No	No	Yes	Yes	No



# SX-5 SANTIAM HD



Redefining top-tier spotting scopes, the SX-5 Santiam HD delivers the relentless performance die-hard hunters and shooters demand. A generous eyepiece provides premium edge-to-edge clarity and unmatched sharpness and definition, while Leupold's unparalleled Twilight Max HD Light Management System eliminates distortion and color aberration; helping you see more in less light. The SX-5 Santiam HD also features a rugged, yet lightweight armor for maximum protection in the harshest conditions and is designed and assembled in the USA. Like all Leupold spotters, the SX-5 Santiam HD is backed by the legendary Leupold Full Lifetime Guarantee.

## KEY BENEFITS

### See more in less light with Twilight Max HD Light Management System

- Maximizes ambient light in extreme low-light environments
- Excellent glare management and virtually eliminates image wash-out caused by stray light
- Premium High Definition edge-to-edge lens clarity

**Delivers more comfortable viewing** with an over-sized eyepiece

**Eliminates eye-strain and fatigue** with generous eyebox

**Provides incredibly sharp images** with ultra-smooth focus

**Increases comfort** with twist-up eyecups

**Stands up to the roughest conditions** with scratch-resistant lenses

**Controls glare** with integrated sun shade

**Mounts easily** with tripod adapter

**Sheds dirt and water for clear, crisp images** with Guard-ion lens coating

**Superior ruggedness** is tested for extreme climates

**Angled and straight eyepiece models available** for different viewing preferences

**Waterproof, fogproof, and guaranteed to perform for life**

**Designed and assembled in the USA**



# SX-5 SANTIAM HD

SX-5 Santiam HD	Actual Magnification	Obj. Aperture (mm)	Weight (oz)	Length (in)	Eye Relief Low/High (mm)	Linear FOV Low/High (ft @ 1000 yd)	Angular FOV	Part Number	UPC Code
27-55x80 (Angled) Shadow Gray	27x-55x	80	68.7	15.0	16.6-19.2	105-73	2.0-1.4	175911	030317020620
27-55x80 (Straight) Shadow Gray	27x-55x	80	68.7	15.75	16.6-19.2	105-73	2.0-1.4	175912	030317020637

## KEY FEATURES

Twilight Max HD Light Management System	Digital camera compatible
Over-sized eyepiece	Protective, soft side case
Twist-up eyecups	Angled and straight eyepiece models
Scratch-resistant lenses	Waterproof
Guard-ion lens coating	Fogproof
Ultra-smooth focus	Guaranteed for life
Integrated sun shade	Designed and assembled in the USA
1/4-20 thread tripod adapter	

# SX-4 PRO GUIDE HD



Built to take on the harshest conditions, this spotter is a must have for any serious hunter or shooter. It features an incredibly rugged magnesium body that is waterproof and fogproof, an oversized straight or angled eyepiece that provides all-day comfort, and Leupold's Twilight Max HD Light Management System, which helps you see more in less light, while reducing glare in direct light. And like all Leupold spotting scopes, the SX-4 Pro Guide HD is guaranteed to perform for life, or we'll repair or replace it for free. Whether you're going on your first big game hunt or helping repeat clients tag out year after year, this spotter should be in your kit.

## KEY BENEFITS

### See more in less light with Twilight Max HD Light Management System

- Maximizes ambient light in extreme low-light environments
- Excellent glare management and virtually eliminates image wash-out caused by stray light
- Premium High Definition edge-to-edge lens clarity

**Delivers more comfortable viewing** with an oversized eyepiece

**Eliminates eye-strain and fatigue** with generous eyebox

**Provides incredibly sharp images** with ultra-smooth focus

**Increases comfort** with twist-up eyecups

**Stands up to the roughest conditions** with

scratch-resistant lenses

**Controls glare** with integrated sun shade

**Mounts easily** with tripod adapter

**Sheds dirt and water for clear, crisp images** with Guard-ion lens coating

**Superior ruggedness** is tested for extreme climates

**Angled and straight eyepiece models available** for different viewing preferences

**Waterproof, fogproof, and guaranteed to perform for life**



# SX-4 PRO GUIDE HD

SX-4 Pro Guide HD	Actual Magnification	Obj. Aperture (mm)	Weight (oz)	Length (in)	Eye Relief Low/High (mm)	Linear FOV Low/High (ft @ 1000 yd)	Angular FOV	Part Number	UPC Code
20-60x85 (Angled) Shadow Gray	20x-60x	85	78.2	17.7	19.0 -17.8	91.7-50.6	1.8-1.0	177597	030317023034
20-60x85 (Straight) Shadow Gray	20x-60x	85	78.2	18.1	19.0 -17.8	91.7-50.6	1.8-1.0	177598	030317023027
15-45x65 (Angled) Shadow Gray	15x-45x	65	62.0	14.7	20.0-17.6	131.0-68.1	2.5-1.3	177599	030317023010
15-45x65 (Straight) Shadow Gray	15x-45x	65	62.0	14.4	20.0-17.6	131.0-68.1	2.5-1.3	177600	030317023003

## KEY FEATURES

- Twilight Max HD Light Management System      1/4-20 thread tripod adapter
- Oversized eyepiece      Protective, soft side case
- Twist-up eyecups      Angled and straight eyepiece models
- Scratch-resistant lenses      Waterproof
- Guard-ion lens coating      Fogproof
- Ultra-smooth focus      Guaranteed for life
- Integrated sun shade



# GOLD RING



Proven performance, outstanding image quality, wide field-of-view, Impact grid reticle, best in class eye relief, and a compact size; our Gold Ring HD spotting scopes have it all. High-definition lenses provide sharper details at maximum magnification, while Leupold's unique Folded Light Path System uses mirrors rather than a heavy prism to create a more compact, lightweight design. This system also handles abuse better than prism systems, making it ideal for hunters or anyone else putting their optics through the paces.

## KEY BENEFITS

### See more in less light with Twilight Max HD Light Management System

- Maximizes ambient light in extreme low-light environments
- Excellent glare management and virtually eliminates image wash-out caused by stray light
- Premium High Definition edge-to-edge lens clarity

**Offers large magnification in a compact design** with folded light path technology

**Maximizes durability and reduces weight** with a magnesium body

**Delivers incredibly sharp images** with ultra-smooth focus

**Offers comfortable viewing options** thanks to an

adjustable eyecup

**Mounts easily** with tripod adapter

**Stands up to the roughest conditions** with scratch-resistant lenses

**Superior ruggedness** is tested for extreme climates

**Waterproof, fogproof, and guaranteed to perform for life**

**Designed, machined, and assembled in the USA**



# GOLD RING

Gold Ring	Actual Magnification	Obj. Aperture (mm)	Weight (oz)	Length (in)	Eye Relief Low/High (mm)	Linear FOV Low/High (ft @ 1000 yd)	Angular FOV	Part Number	UPC Code
12-40x60 Shadow Gray	12x-40x	60	37.0	12.4	30.0/30.0	168/52	3.2-1.0	120371	030317006747
12-40x60 HD Shadow Gray	12x-40x	60	37.0	12.4	30.0/30.0	168/52	3.2-1.0	120372	030317006778
								<b>A</b> 120373	030317006730
20-60x80 Shadow Gray	20x-60x	80	61.8	15.5	30.0/30.0	121/42	2.3-0.8	120376	030317006785
								<b>A</b> 120377	030317006754

## KEY FEATURES

- Twilight Max Light Management System and Twilight Max HD Light Management System
- Adjustable eyecup
- 1/4-20 thread tripod adapter
- Scratch-resistant lenses
- Digital camera compatible
- Optional first focal plane reticle
- Waterproof
- Folded light path design
- Fogproof
- Magnesium body
- Guaranteed for life
- Ultra-smooth focus
- Designed, machined, and assembled in the USA

## RETICLE



**A**  
Impact Reticle

# GOLD RING COMPACT



Gold Ring Compact spotting scopes lighten your load while delivering performance and features that rival larger models. Carbon fiber construction keeps them ultralight and incredibly tough, and the Twilight Light Management System ensures a vivid, sharp image.

## KEY BENEFITS

### See more in less light with Twilight Light Management System

- Amplifies ambient light in low-light environments
- Good glare management and minimizes image wash-out caused by stray light
- Premium lens clarity

**Offers exceptional durability** with carbon fiber body

**Maximizes pack-ability** thanks to a lightweight, compact housing

**Offers comfortable viewing options** thanks to an adjustable eyecup

**Mounts easily** with tripod adapter

**Stands up to the roughest conditions** with scratch-resistant lenses

**Superior ruggedness** is tested for extreme climates

**Waterproof, fogproof, and guaranteed to perform for life**

**Designed, machined, and assembled in the USA**



# GOLD RING COMPACT

Gold Ring Compact	Actual Magnification	Obj. Aperture (mm)	Weight (oz)	Length (in)	Eye Relief Low/High (mm)	Linear FOV Low/High (ft @ 1000 yd)	Angular FOV	Part Number	UPC Code
10-20x40 Shadow Gray	10x-20x	40	15.8	7.5	18.5/17.2	199/136	3.8-2.6	120374	030317006792
15-30x50 Shadow Gray	15x-30x	50	21.5	11.0	17.5/17.1	136/89	2.6-1.7	120375	030317006723

## KEY FEATURES

Twilight Light Management System	1/4-20 thread tripod adapter
Scratch-resistant lenses	Waterproof
Carbon fiber construction	Fogproof
Lightweight, compact housing	Guaranteed for life
Adjustable eyecup	Designed, machined, and assembled in the USA

# LEUPOLD MARKSMAN

OFFERED EXCLUSIVELY THROUGH BASS PRO SHOPS/CABELA'S



The Leupold Marksman 20-60x60mm spotting scope is up to any challenge. It has all of the features you need for a lifetime of use in the field with none of the additional cost. It's built with a rugged lightweight polycarbonate body to stand up to harsh environments. On the inside, our Twilight Light Management System is hard at work, letting you see more in less light. Backed by our lifetime guarantee, it's also waterproof and fogproof. It comes standard with lens covers and soft case.

## KEY BENEFITS

### See more in less light with Twilight Light Management System

- Amplifies ambient light in low-light environments
- Good glare management and minimizes image wash-out caused by stray light
- Premium lens clarity

**Delivers incredibly sharp images** with ultra-smooth focus

**Controls glare** with integrated sun shade

**Stays secure in all conditions** thanks to easy-grip rubber armor

**Cuts ounces** with a lightweight body

**Mounts easily** with tripod adapter

**Increases comfort** with twist-up eyecup

**Superior ruggedness** is tested for extreme climates

**Waterproof, fogproof, and guaranteed to perform for life**



# LEUPOLD MARKSMAN

Leupold Marksman	Actual Magnification	Obj. Aperture (mm)	Weight (oz)	Length (in)	Eye Relief Low/High (mm)	Linear FOV Low/High (ft @ 1000 yd)	Angular FOV	Part Number	UPC Code
20-60x60 Black	20x-60x	60	37.2	14.4	17.0/14.0	114/51	2.2-1.0	176772	030317021603

## KEY FEATURES

Twilight Light Management System	Easy-grip armor
Retractable lens shade	Retractable lens shade
Precision focus adjustment	Twist-up eyecup
Easy-turn power selector	1/4-20 thread tripod adapter
Focus down to 20 feet	Waterproof
Lightweight polycarbonate body	Fogproof
	Guaranteed for life

# MARK 4 TACTICAL



The Mark 4<sup>®</sup> Tactical spotting scope gives you the brightness and clarity necessary for positive target identification under any conditions. Built to survive shocks, blows, drops, and impacts, it's not only tough, it's also waterproof and fogproof. Multiple reticle options make calling corrections quick and efficient. Countless military sniper teams have trusted the Mark 4 Tactical spotting scope. You can depend on it, too.

## KEY BENEFITS

### See more in less light with Twilight Max Light Management System

- Intensifies ambient light in low-light environments
- Great glare management and drastically reduces image wash-out caused by stray light
- Premium edge-to-edge lens clarity

### Offers large magnification in a compact design with folded light path design

### Provides measuring, ranging, and spotting capabilities with available Mil reticles

### Maximizes durability and reduces weight with a magnesium body

### Delivers incredibly sharp images with ultra-smooth focus

### Offers comfortable viewing options thanks to an adjustable eyecup

### Mounts easily with tripod adapter

### Stands up to the roughest conditions with scratch-resistant lenses

### Superior ruggedness is tested for extreme climates

### Waterproof, fogproof, and guaranteed to perform for life

### Designed, machined, and assembled in the USA



# MARK 4 TACTICAL

Mark 4 Tactical	Actual Magnification	Obj. Aperture (mm)	Weight (oz)	Length (in)	Eye Relief Low/High (mm)	Linear FOV Low/High (ft @ 1000 yd)	Angular FOV	Part Number	UPC Code
12-40x60 Black	12x-40x	60	37.0	12.4	30.0/30.0	168/52	3.2-1.0	<b>A</b> 53756	030317537562
								<b>B</b> 60040	030317600402
20-60x80 Black	20x-60x	80	61.8	15.5	30.0/30.0	121/42	2.3-0.8	<b>A</b> 110825	030317108250
								<b>B</b> 110826	030317108267

## KEY FEATURES





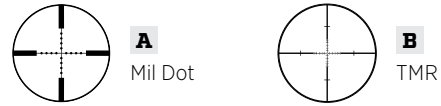

- Twilight Max Light Management System: Digital camera compatible
- Scratch-resistant lenses: 1/4-20 thread tripod adapter
- Optional first focal plane reticles: Waterproof
- Folded light path design: Fogproof
- Armor-coated body: Guaranteed for life
- Ultra-smooth focus: Designed, machined, and assembled in the USA
- Fold-down rubber eyecups

## AVAILABLE RETICLES





# COMPARISON CHART

Product	RX-2800 TBR/W	RX-1600 TBR/W	RX-1300 TBR	RX-FullDraw 4	RX-FullDraw 3	RX-950
						
Max Range	2,800 yards	1,600 yards	1,300 yards	1,200 yards	1,300 yards	950 yards
Tree Range	2,400 yards	1,400 yards	1,100 yards	1,100 yards	1,100 yards	900 yards
Deer Range	1,800 yards	1,000 yards	900 yards	900 yards	900 yards	800 yards
Display Type	High-contrast red OLED	High-contrast red OLED	High light transmission black LCD	High-contrast red OLED	High light transmission black LCD	High-contrast black LCD
Magnification	7x	6x	6x	6x	6x	6x
Ballistics	TBR/W	Bow Mode TBR/W	Bow Mode TBR	Archer's Advantage with FlightPath	Bow mode	Tig
Weight	7.9 oz	7.5 oz	7.0 oz	7.5oz	7.0 oz	6.2 oz



# RX-2800 TBR/W



The RX-2800 TBR/W rangefinder breaks new ground. With our new Alpha IQ ranging engine and optical design, the RX-2800 lets you make the best of any situation. Whether ringing steel at a mile or closing the distance on a herd of elk, this rangefinder will outperform in any conditions, giving you the advantage shot after shot.

## KEY BENEFITS

**Provides ballistically calculated ranges** for uphill/downhill shooting, using True Ballistic Range/Wind (TBR/W) technology

**Delivers faster, more accurate readings** with the Alpha IQ ranging engine

**Provides exceptionally bright and clear images** with a high light transmission red OLED display

**Makes ranging long distances easy** using 7x magnification

**Boasts 2,800-yard ranging distance** on reflective objects and 2,400 yards on trees

**Maximizes durability** with a high-impact aluminum chassis

**Stays secure in all conditions** thanks to easy-grip rubber armor

**Mounts easily** with a 1/4-20 tripod adapter

**Waterproof and extreme climate tested**



# RX-2800 TBR/W

RX-2800 TBR/W Laser Rangefinder	Actual Magnification	Maximum Range (yds) Reflective Trees	Deer	Obj. Aperture	Weight (oz)	Length (in)	Linear FOV (ft @ 1000 yd)	Part Number	UPC Code
7x27 Black	7x	2,800	2,400	1,800	27mm	7.9	4.3	318	171910 030317013073

## KEY FEATURES

- 7x magnification
  - +/- 1 yard accuracy to 2,800 yards
  - High light transmission red OLED display
  - Fully multi-coated lenses
  - Lightening fast and accurate readings
  - Scan mode
  - True Ballistic Range with Wind (TBR/W)
    - Ballistic compensation system to 800 yards
    - Wind hold outputs
- Lightweight, aluminum chassis
  - Impact-resistant polymer housing
  - Rubberized armor
  - Uses 1 CR123 battery
  - Three selectable reticles
  - Waterproof

## SELECTABLE RETICLES

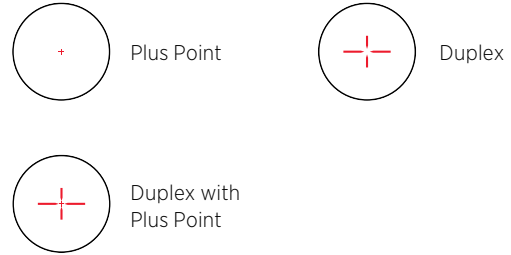

# RX-1600i TBR/W



The RX-1600i TBR/W is the longest ranging unit in its class. We've integrated our own proprietary ranging engine for elite performance and accuracy. With an incredibly rugged, lightweight aluminum housing, the RX-1600i begs to be used, even in the harshest conditions.

## KEY BENEFITS

**Provides ballistically calculated ranges** for uphill/downhill shooting, using True Ballistic Range/Wind (TBR/W) technology

**Generates arrow drops out to 175 yards** with Bow-specific settings

**Delivers incredibly fast ranging speeds** using a high-performance laser engine

**Provides exceptionally bright and clear images** with a high light transmission red OLED display

**Makes ranging long distances easy** using 6x magnification

**Boasts 1,600-yard ranging distance** on reflective objects and 1,400 yards on trees

**Maximizes durability** with a high-impact aluminum housing

**Stays secure in all conditions** thanks to easy-grip rubber armor

**100% waterproof and extreme climate tested**



# RX-1600i TBR/W

RX-1600i TBR/W Laser Rangefinder	Actual Magnification	Maximum Range (yds)			Obj. Aperture	Weight (oz)	Length (in)	Linear FOV (ft @ 1000 yd)	Part Number		UPC Code	
		Reflective	Trees	Deer					A	B	C	
6x22	6x	1,600	1,400	1,000	22	7.5	3.8	315	A 173805		030317017576	
									B 173806		030317017569	
									C 173807		030317017552	

## KEY FEATURES

- 6x magnification
- High light transmission red OLED display
- +/- 1/2 yard accuracy to 125 yards
- Fully multi-coated lens system
- Scan mode
- Built-in inclinometer
- True Ballistic Range with Wind (TBR/W)
  - Ballistic compensation system
  - Wind hold outputs
- Proprietary advanced ranging engine
- Lightweight aluminum housing
- Uses 1 CR2 battery
- Three selectable reticles
- Waterproof

## AVAILABLE FINISHES

- A** Black/Gray
- B** Mossy Oak Blaze Orange
- C** Mossy Oak Break-Up Country

## SELECTABLE RETICLES

- Plus Point
- Duplex
- Duplex with Plus Point

# RX-1300i TBR



With ½ yard accuracy, 6x magnification, and True Ballistic Range technology, the RX-1300i TBR will give you the confidence you need, shot after shot. We've packed a ton of features in an easy to carry unit that's as versatile as it is small. The result is a piece of gear that will never leave your kit. From the range to the mountains, the RX-1300i TBR will never let you down.

## KEY BENEFITS

**Provides ballistically calculated ranges** for uphill/downhill shooting, using True Ballistic Range (TBR) technology

**Generates arrow drops out to 175 yards** with Bow-specific settings

**Delivers incredibly fast ranging speeds** using a high-performance DNA (Digitally eNhanced Accuracy) laser engine

**Delivers exceptionally bright and clear images** with high light transmission LCD display

**Makes ranging long distances easy** using 6x magnification

**Easily measure game in the field** using Trophy Scale

**Boasts 1,300-yard ranging distance** on reflective objects and 1,100 on trees

**Provides a solid grip** with an ergonomic housing design

**Stays secure in all conditions** thanks to easy-grip rubber armor

**100% waterproof and extreme climate tested**



# RX-1300i TBR

RX-1300i TBR Laser Rangefinder	Actual Magnification	Maximum Range (yds) Reflective	Trees	Deer	Obj. Aperture	Weight (oz)	Length (in)	Linear FOV (ft @ 1000 yd)	Part Number	UPC Code
6x23 Black / Gray	6x	1,300	1,100	900	23	7.0	4.0	315	174555	030317018467

## KEY FEATURES

- 6x magnification
  - +/- 1/2 yard accuracy to 125 yards
  - High light transmission LCD display
  - Fully multi-coated lens system
  - Scan mode
  - Built-in inclinometer
  - True Ballistic Range (TBR) technology
    - Ballistic compensation system
- Proprietary advanced DNA ranging engine
  - Lightweight polymer housing
  - Aggressive rubberized armor
  - Three selectable reticles
  - Ergonomic housing design
  - Waterproof

## SELECTABLE RETICLES

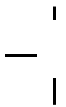
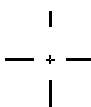
-  Plus Point
-  Duplex
-  Duplex with Plus Point



# RX-FULLDRAW 4

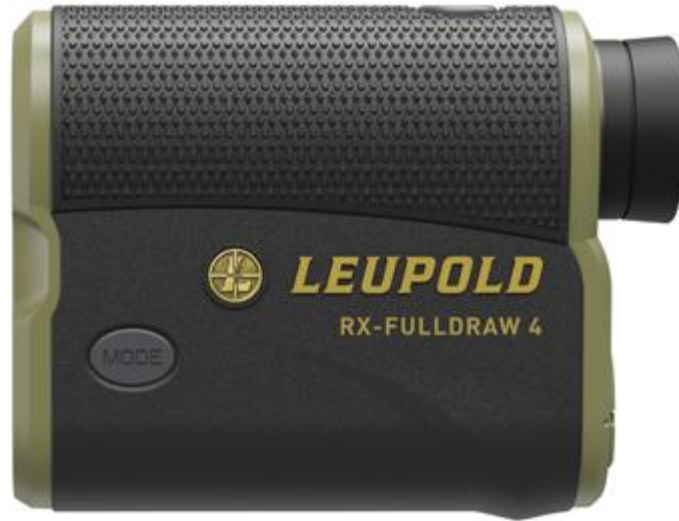

Your bow is custom-built to you, so your rangefinder should be, too. The RX-Fulldraw 4 combines the lightning-fast accuracy of Leupold's DNA® engine with the acclaimed Archer's Advantage™ software, making it the most ballistically advanced rangefinder on the market. Using your personal ballistics, shot distance, and angle compensation, the Fulldraw 4 calculates laser-accurate ranges based on your specific gear. Loaded with features designed for the modern archer, like Flightpath™ technology, we take the guess work out of achieving the perfect shot every time.

## KEY BENEFITS

**Use Flightpath technology** to determine if your arrow will clear obstructions between you and your target out to 150 yards

**Archer's Advantage software** uses your arrow weight, arrow velocity, and peep height to calculate extremely accurate ballistic solutions

**Bow-specific settings** provides arrow drops out to 175 yards

**Provides incredibly fast ranging speeds** using a high-performance laser engine

**Delivers exceptionally bright and clear images** with high light transmission OLED display

**Makes ranging long distances easy** using 6x magnification

**Boasts 1,200-yard ranging distance** on reflective objects and 1,100 on trees

**Stays secure in all conditions** thanks to easy-grip rubber armor and ergonomic housing design

**100% waterproof and extreme climate tested**



# RX-FULLDRAW 4

RX-FullDraw 4 Laser Rangefinder	Actual Magnification	Maximum Range (yds) Reflective	Trees	Deer	Obj. Aperture	Weight (oz)	Length (in)	Linear FOV (ft @ 1000 yd)	Part Number	UPC Code
6x22 Green	6x	1,200	1,100	900	22	7.5	3.8	315	178763	030317024956

## KEY FEATURES

- 6x magnification
- +/- 1/2 yard accuracy to 125 yards
- Fully multi-coated lens system
- Scan mode
- Archery specific angle calculations out to 175 yards
- Proprietary advanced ranging engine
- Lightweight aluminum housing
- Rubberized armor
- Three selectable reticles
- Uses 1 CR2 battery
- Waterproof

## SELECTABLE RETICLES

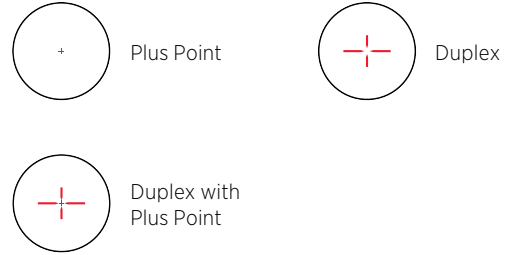

# RX-FULLDRAW 3



The Leupold RX-FullDraw 3 delivers archery-specific performance in an incredibly compact package. With features tailored to the modern archer, we take the guess work out of achieving the perfect shot every time.

## KEY BENEFITS

**Bow-specific settings** provides arrow drops out to 175 yards

**Provides incredibly fast ranging speeds** using a high-performance laser engine

**Delivers exceptionally bright and clear images** with high light transmission LCD display

**Makes ranging long distances easy** using 6x magnification

**Easily measure game in the field** using Trophy Scale

**Boasts 1,300-yard ranging distance** on reflective objects and 1,100 on trees

**Provides a solid grip** with an ergonomic housing design

**Stays secure in all conditions** thanks to easy-grip rubber armor

**100% waterproof and extreme climate tested**



# RX-FULLDRAW 3

RX-FullDraw 3 Laser Rangefinder	Actual Magnification	Maximum Range (yds) Reflective	Trees	Deer	Obj. Aperture	Weight (oz)	Length (in)	Linear FOV (ft @ 1000 yd)	Part Number	UPC Code
6x23 Green	6x	1,300	1,100	900	23	7.0	4.0	315	174557	030317018450

## KEY FEATURES

6x magnification	Lightweight polymer housing
+/- 1/2 yard accuracy to 125 yards	Rubberized armor
Fully multi-coated lens system	Ergonomic housing design
Trophy Scale	Three selectable reticles
Scan mode	Uses 1 CR2 battery
Archery specific angle calculations out to 175 yards	Waterproof
Proprietary advanced ranging engine	

## SELECTABLE RETICLES

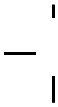
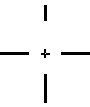
	Plus Point		Duplex
	Duplex with Plus Point		

# LEUPOLD MARKSMAN 1000

OFFERED EXCLUSIVELY THROUGH BASS PRO SHOPS/CABELA'S



The Leupold Marksman 1000 rangefinder makes getting out to 1,000 yards quick and easy. Its image is not only bright in low-light, but the high contrast display makes reading yardages easy in any environment. Lightweight, compact, and waterproof, the Leupold Marksman 1000 is there when you need to go the distance. Includes battery and cordura case.

## KEY BENEFITS

**Provides incredibly fast ranging speeds** with a high-performance laser engine

**Delivers 1,000-yard ranging distance** on reflective objects and 900 yards on trees

**Delivers exceptionally bright and clear images** with a high light transmission LCD display

**Stays secure in all conditions** thanks to easy-grip rubber armor

**Makes ranging long distances easy** using 6x magnification

**100% waterproof and extreme climate tested**



# LEUPOLD MARKSMAN 1000

Leupold Marksman 1000	Actual Magnification	Maximum Range (yds) Reflective Trees	Deer	Obj. Aperture	Weight (oz)	Length (in)	Linear FOV (ft @ 1000 yd)	Part Number	UPC Code	
6x20 Black	6x	1,000	900	800	20	6.2	3.8	367	176770	030317021580

## KEY FEATURES

- 6x magnification
- +/- 1/2 yard accuracy to 125 yards
- Easy-to-read high light transmission LCD display
- Bright clear image
- Scan mode
- Built-in inclinometer
- Quick accurate ranging - Equivalent horizontal range distance
- Angle measurement display
- Proprietary advanced ranging engine
- Ranges in yards and meters
- Lightweight, rugged polymer housing
- Easy-grip rubberized armor
- Waterproof

## RETICLE

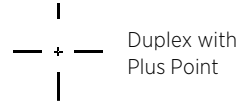

# RX-950



The RX-950 rangefinder makes getting out to 950 yards quick and easy. Its image is not only bright in low-light, but the high-contrast LCD display makes reading yardages easy in any environment. Lightweight, compact, and waterproof, the RX-950 is there when you need to go the distance. Includes battery and cordura case.

## KEY BENEFITS

**Provides incredibly fast ranging speeds** with a high-performance laser engine

**Delivers exceptionally bright and clear images** with a high-contrast LCD display

**Makes ranging long distances easy** using 6x magnification

**Delivers 950-yard ranging distance** on reflective objects and 900 yards on trees

**Stays secure in all conditions** thanks to easy-grip rubber armor

**100% waterproof and extreme climate tested**



# RX-950

RX-950 Laser Rangefinder	Actual Magnification	Maximum Range (yds) Reflective	Trees	Deer	Obj. Aperture	Weight (oz)	Length (in)	Linear FOV (ft @ 1000 yd)	Part Number	UPC Code
6x20 Black	6x	950	900	800	20	6.2	3.8	367	176770	030317021597

## KEY FEATURES

- 6x magnification
- Angle measurement display
- +/- 1 yard accuracy to 950 yards
- Proprietary advanced ranging engine
- Easy-to-read high-contrast LCD display
- Ranges in yards and meters
- Scan mode
- Lightweight, rugged polymer housing
- Built-in inclinometer
- Easy-grip rubberized armor
- Quick, accurate ranging
- Equivalent horizontal range distance
- Waterproof

## RETICLE





# VENDETTA 2



The Leupold® Vendetta™ 2 bow-mounted rangefinder will revolutionize the way you hunt and dramatically improve your chance of success. Not since the introduction of the compound bow has there been such a dramatic innovation in bowhunting. The Vendetta 2 can be mounted to a compound bow or a crossbow to give you an instant and precise digital readout of your angle compensated range to target, with no excessive movement or noise. Simply push the trigger pad for an instant reading or hold the trigger for 3 seconds and release to enter a 40 second scan mode which continually adjusts distance, angles and elevation as your target moves. The Vendetta 2 will increase your success in the field and is backed by the Leupold Gold Ring Electronics Warranty.

## KEY BENEFITS

**Provides easy-to-read, high-contrast numbers** with an LED display

**Provides angle-compensated ranges** using True Ballistic Range (TBR) technology

**Quickly setup and dial in** with adjustable mount

**Delivers quick motionless ranges** using a tethered pressure pad

**Provides accurate ranges** up to 75 yards

**Delivers +/- 1 yard accuracy** at full draw

**Ranges update for 45 seconds** while the target is on the move

**Easy crossbow installation** with 1-inch scope mount

**100% waterproof and extreme climate tested**



# VENDETTA 2

Vendetta 2	Maximum Range (yds)	Weight (oz)	Length (in)	Part Number	UPC Code
Vendetta 2 Black	75	11.0	2.8	174557	030317018450

## KEY FEATURES

- True Ballistic Range (TBR)
- Bow mounted
- CR2 lithium battery
- LED display
- One touch continuous scan
- Waterproof
- Laser dot alignment

# LTO-TRACKER 2 HD



Being aware of your surroundings not only takes skill, it takes the right tools. The Leupold LTO-Tracker 2 HD is the next evolution of thermal that allows you to see through darkness, track an animal, aid in search and rescue, or any other tasks where identifying a heat source might come in handy. The LTO-Tracker 2 HD features our new Beacon mode, which allows you to quickly recalibrate the screen to improve daytime use. This makes it easier to identify objects that have a similar heat signature to their backgrounds—like a downed deer on a sunny hillside. Housed in an all-aluminum body that's only 5.5 inches long and 7 ounces, it's ready to go wherever your next adventure takes you.

## KEY BENEFITS

**Delivers clear thermal images** with high-resolution 390x390 display

**Provides increased temperature sensitivity** with a 320x240 thermal sensor

**Improves daytime use** with Beacon mode's screen calibration

**Maximizes durability** with a Gorilla Glass full-circle display

**Offers long-range scanning** with a 750-yard detection distance

**Provides more efficient game recovery** with a 300-yard deer detection distance

**Improves identification at longer distances** with 7x digital zoom

**Offers unmatched durability** with a lightweight aluminum housing

**Easy-to-carry, compact design**



# LTO-TRACKER 2 HD

Thermal Sensor	Detection Distance (yds)	Typical Deer Detection Distance (yds)	Angular FOV	Thermal Detection Range	Frame Rate	Max Zoom	Display	Display Resolution	Startup Time	Battery Type / Life	Part Number	UPC Code
320x240	750	300	18°	-40°F to 572°F	>25Hz	7x Digital	1.2" Full Round AMOLED	390x390	< 3 Seconds	CR123 / 3hr	177188	030317022389

## KEY FEATURES

- 390x390 high-resolution display
- 300-yard deer detection distance
- 320x240 thermal sensor
- 7x digital zoom
- Beacon mode
- Six color palettes
- Manual gain control
- Dimmable display
- Gorilla Glass full-circle display
- Lightweight aluminum housing
- 750-yard detection distance
- Scopecoat and lens covers included

## AVAILABLE COLOR PALETTES

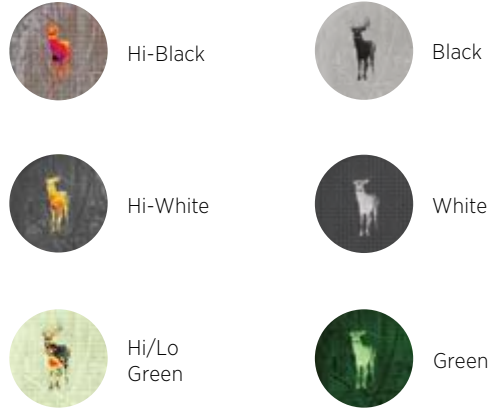

# LTO-TRACKER 2



Compact and light enough to take on even the farthest backcountry hunt, your LTO-Tracker 2 shows you the heat signature of game, blood trails, and more—day or night. The LTO-Tracker 2 features our new Beacon mode, which allows you to quickly recalibrate the screen to improve daytime use. This makes it easier to identify objects that have a similar heat signature to their backgrounds. Like a good knife, binoculars, and a rangefinder, it's essential gear.

## KEY BENEFITS

**Delivers clear thermal images** with a 240x204 resolution display

**Provides increased temperature sensitivity** with a 206x156 thermal sensor

**Improves daytime use** with Beacon mode's screen calibration

**Offers long-range scanning** with a 600-yard detection distance

**Provides more efficient game recovery** with a 250-yard deer detection distance

**Improves identification at longer distances** with 7x digital zoom

**Offers unmatched durability** with a lightweight aluminum housing

**Easy-to-carry, compact design**



# LTO-TRACKER 2

Thermal Sensor	Detection Distance (yds)	Typical Deer Detection Distance (yds)	Angular FOV	Thermal Detection Range	Frame Rate	Max Zoom	Display	Display Resolution	Startup Time	Battery Type / Life	Part Number	UPC Code
206x156	600	250	14°	-40°F to 572°F	30Hz	7x Digital	1.2" Flat Bottom AMOLED	240x204	< 5 Seconds	CR123/10hr	177187	030317022372





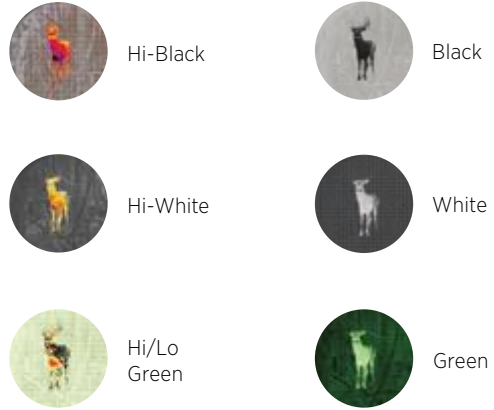

## KEY FEATURES

- 240x204 resolution display
- 250-yard deer detection distance
- 206x156 thermal sensor
- 7x digital zoom
- Beacon mode
- Six color palettes
- Manual gain control
- Dimmable display
- 600-yard detection distance
- Lightweight aluminum housing

## AVAILABLE COLOR PALETTES



# COMPARISON CHART

Product	Kaimal	Bechara	Packout	Switchback	Tracker
					
ANSI Z87.1+	•	•	•	•	•
Rx-Ready	•	•	•	•	
Polarized	•	•	•	•	•
Frame Fit	Narrow-Regular	Regular-Wide	Regular	Regular-Wide	Narrow-Regular
100% UVA Protection	•	•	•	•	•
100% UVB Protection	•	•	•	•	•





# KATMAI



The Katmai is the choice for any adventurer. Lightweight, rugged, and exceptionally clear; they can be trusted to keep your eyes fresh and your vision true.

## KEY BENEFITS

**Daylight Max** provides UV protection for optimal performance in bright conditions

**Diamondcoat Scratch Resistance** reduces surface scratches with a hardened surface coating

**No-slip Bridge** provides all day comfort with no-slip, soft-touch rubber bridge pads

**Lifetime Guarantee** protects against manufacturer's defects for the life of the product

**In-Fused Polarized Lenses** eliminate glare and keep your eyes fresh on the water and in the field

**Guard-ion Hydrophobic Coating** sheds dirt and water for a clear, crisp image

**Rx Ready** compatible with prescription lens requirements



# KATMAI

Katmai	ANSI Z87.1+	Rx-Ready	Polarized	Frame Fit	100% UVA Protection	100% UVB Protection	Part Number	UPC Code
Matte Black, Shadow Gray Flash		●	●	Narrow-Regular	●	●	179097	030317025847
Matte Tortoise, Bronze Mirror		●	●	Narrow-Regular	●	●	179098	030317025571
Matte Black, Emerald Mirror		●	●	Narrow-Regular	●	●	179099	030317025854
Matte Black, Shadow Gray		●		Narrow-Regular	●	●	179100	030317025298
Matte Black, Orange Mirror		●	●	Narrow-Regular	●	●	179631	030317026370

## AVAILABLE COLOR STYLES



179097



179098



179099



179100



179631

# BECNARA



The Becnara fuses Leupold performance with everyday style. Polarized, rugged, and incredibly clear; they will never let you down. Any day or any adventure, the Becnara stands out in the field.

## KEY BENEFITS

**Daylight Max** provides UV protection for optimal performance in bright conditions

**Diamondcoat Scratch Resistance** reduces surface scratches with a hardened surface coating

**No-slip Bridge** provides all day comfort with no-slip, soft-touch rubber bridge pads

**Lifetime Guarantee** protects against manufacturer's defects for the life of the product

**In-Fused Polarized Lenses** eliminate glare and keep your eyes fresh on the water and in the field

**Guard-ion Hydrophobic Coating** sheds dirt and water for a clear, crisp image

**Rx Ready** compatible with prescription lens requirements



# BECNARA

Becnara	ANSI Z87.1+	Rx-Ready	Polarized	Frame Fit	100% UVA Protection	100% UVB Protection	Part Number	UPC Code
Matte Black/Tortoise, Bronze Mirror		●	●	Regular-Wide	●	●	179101	030317025489
Matte Black/Gloss Black, Shadow Gray Flash		●	●	Regular-Wide	●	●	179102	030317025861
Matte Black, Bronze Mirror		●	●	Regular-Wide	●	●	179103	030317025649
Matte Tortoise, Blue Mirror		●	●	Regular-Wide	●	●	179632	030317026356
Matte Black/Gloss Black, Orange Mirror		●	●	Regular-Wide	●	●	179633	030317026387

## AVAILABLE COLOR STYLES



179101



179102



179103



179632



179633

# PACKOUT



The Packout is the go-to option for any hunter or shooter. ANSI Z87.1+ ballistic protection alongside our proven optical clarity make the Packout perfect for every adventure and everyday wear.

## KEY BENEFITS

**Daylight Max** provides UV protection for optimal performance in bright conditions

**ANSI Z87.1+ Ballistic Rating** meets or exceeds ANSI high-velocity impact standards for eye protection

**Diamondcoat Scratch Resistance** reduces surface scratches with a hardened surface coating

**No-slip Bridge** provides all day comfort with no-slip, soft-touch rubber bridge pads

**Lifetime Guarantee** protects against manufacturer's defects for the life of the product

**In-Fused Polarized Lenses** eliminate glare and keep your eyes fresh on the water and in the field

**Guard-ion Hydrophobic Coating** sheds dirt and water for a clear, crisp image

**Rx Ready** compatible with prescription lens requirements



# PACKOUT

Packout	ANSI Z87.1+	Rx-Ready	Polarized	Frame Fit	100% UVA Protection	100% UVB Protection	Part Number	UPC Code
Matte Tortoise, Bronze Mirror	●	●	●	Regular	●	●	179094	030317025564
Matte Black, Emerald Mirror	●	●	●	Regular	●	●	179095	030317025311
Matte Black, Shadow Gray Flash	●	●	●	Regular	●	●	179096	030317025304
Matte Tortoise, Blue Mirror	●	●	●	Regular	●	●	179630	030317026394

## AVAILABLE COLOR STYLES



179094



179095



179096



179630

# SWITCHBACK



Comfortable on the range, in the field, or on the ride home, the Switchback will quickly become a favorite addition to your everyday kit. ANSI Z87.1+ ballistic protection, lightweight comfort, and unquestionable clarity gives you everything you need and nothing you don't.

## KEY BENEFITS

**Daylight Max** provides UV protection for optimal performance in bright conditions

**ANSI Z87.1+ Ballistic Rating** meets or exceeds ANSI high-velocity impact standards for eye protection

**Diamondcoat Scratch Resistance** reduces surface scratches with a hardened surface coating

**No-slip Bridge** provides all day comfort with no-slip, soft-touch rubber bridge pads

**Lifetime Guarantee** protects against manufacturer's defects for the life of the product

**In-Fused Polarized Lenses** eliminate glare and keep your eyes fresh on the water and in the field

**Guard-ion Hydrophobic Coating** sheds dirt and water for a clear, crisp image

**Rx Ready** compatible with prescription lens requirements



# SWITCHBACK

Switchback	ANSI Z87.1+	Rx-Ready	Polarized	Frame Fit	100% UVA Protection	100% UVB Protection	Part Number	UPC Code
Matte Tortoise, Bronze Mirror	●	●	●	Regular-Wide	●	●	179091	030317025328
Matte Black, Shadow Gray Flash	●	●	●	Regular-Wide	●	●	179092	030317025762
Matte Black, Emerald Mirror	●	●	●	Regular-Wide	●	●	179093	030317025779
Matte Gray, Blue Mirror	●	●	●	Regular-Wide	●	●	179629	030317026363

## AVAILABLE COLOR STYLES



179091



179092



179093



179629



# TRACER



When you're a dedicated shooter, the Tracer is an absolute must-have. ANSI Z87.1+ ballistic protection, interchangeable lenses (included), and weather-resistant coatings are combined with Leupold's unmatched clarity and durability.

## KEY BENEFITS

**Daylight Max** provides UV protection for optimal performance in bright conditions

**ANSI Z87.1+ Ballistic Rating** meets or exceeds ANSI high-velocity impact standards for eye protection

**Diamondcoat Scratch Resistance** reduces surface scratches with a hardened surface coating

**No-slip Bridge** provides all day comfort with no-slip, soft-touch rubber bridge pads

**Limited Lifetime Guarantee** protects against manufacturer's defects for the life of the product

**Easily Interchangeable Lenses** maintain maximum protection in all light conditions

**In-Fused Polarized Lenses** eliminate glare and keep your eyes fresh on the water and in the field

**Guard-ion Hydrophobic Coating** sheds dirt and water for a clear, crisp image



# TRACER

Tracer	ANSI Z87.1+	Rx-Ready	Polarized	Frame Fit	100% UVA Protection	100% UVB Protection	Part Number	UPC Code
Matte Black, Shadow Gray	•			Narrow-Regular	•	•	179089	030317025373
Shadow Tan, Bronze Mirror	•		•	Narrow-Regular	•	•	179090	030317025786

## AVAILABLE COLOR STYLES



179089



179090

# PRO GEAR ORDERING INFO

Equipment	Color	Part Number	UPC Code
Window Mount	Black	58400	030317584009
Quick Release Binocular Harness	Black	55895	030317558956
Scope Cover, S	Black	53572	030317535728
Scope Cover, M	Black	53574	030317535742
Scope Cover, L	Black	53576	030317535766
Scope Cover, XL	Black	53578	030317535780
Scope Cover, 2XL	Black	53580	030317535803
Carbon Fiber Tripod Kit	Black	170600	030317010751
Compact Aluminum Tripod Kit	Black	170602	030317010775
Leupold Zoom SVS Universal Adapter	Black	170526	030317009496
Trek Poles - Carbon Fiber	Black	170592	030317009601
Binocular Tripod Adapter Tray	Black	172625	030317014636
Compact Tabletop Tripod	Black	172626	030317014841
GO Series Gear	Color	Part Number	UPC Code
GO Afield Binocular Harness XF	Shadow Gray / Tan	172543	030317014056
Optics GO Bag XF	Shadow Gray / Tan	172545	030317014285
GO DRY 30L Gear Duffie	Shadow Gray	172605	030317014490
GO DRY 40L Gear Duffie	Shadow Gray	172606	030317014506
GO DRY Gear Bag 1L	Tan	172608	030317014834
GO DRY Gear Bag 2L	Tan	172611	030317014704
GO DRY Gear Bag 4L	Tan	172612	030317014407
GO DRY Gear Bag 8L	Tan	172613	030317014513
GO AFIELD Binocular Case, S	Shadow Gray / Tan	172614	030317014933
GO AFIELD Binocular Case, M	Shadow Gray / Tan	172615	030317014940
GO AFIELD Binocular Case, L	Shadow Gray / Tan	172616	030317014599

# PRO GEAR ORDERING INFO CONT.

Tools & Accessories	Color	Part Number	UPC Code
Lens Pen	Black	48807	03031748807
Mounting Tool	Black	52296	030317522964
Ring Wrench	Black	48762	030317487621
Torx Driver	Black	50818	030317508180
Torx® Screw Kit	Black	52395	030317523954
Dealer Parts Kit	Black	63040	030317630409
Alumina 2.5" - 50mm Lens Shade Matte	Black	52350	030317523503
Alumina 2.5" - 40mm Lens Shade Matte	Black	56187	030317561871
42mm Lens Shade, VX-5HD & VX-6/6HD	Black	118768	030317004194
44mm Lens Shade, VX-5HD, VX-6/6HD & Mark 5HD	Black	118769	030317004200
45mm Lens Shade, Competition Series	Black	54180	030317541804
50mm Lens Shade, VX-5HD & VX-6/6HD	Black	118770	030317004217
52mm Lens Shade, VX-5HD & VX-6/6HD	Black	118771	030317004170
56mm Lens Shade, VX-5HD, VX-6/6HD & Mark 5HD	Black	118772	030317004187
Threaded 50 Ft. Focus Adapter	Black	59021	030317590215
Alumina Flip Back Lens Cover - 56 - VX-5HD, VX-6/6HD & Mark 5HD	Black	119737	030317005979
Alumina Flip Back Lens Cover - 52mm - VX-5HD, VX-6/6HD & Mark 5HD	Black	117610	030317176105
Alumina Flip Back Lens Cover - 50mm	Black	59050	030317590505
Alumina Flip Back Lens Cover - 44mm - VX-5HD, VX-6/6HD & Mark 5HD	Black	117608	030317176082
Alumina Flip Back Lens Cover - 42mm - VX-5HD, VX-6/6HD & Mark 5HD	Black	117607	030317176075
Alumina Flip Back Lens Cover - 40mm	Black	59045	030317590451
Alumina Flip Back Lens Cover - 36mm	Black	59040	030317590406
Alumina Flip Back Lens Cover - 32-33mm	Black	59035	030317590352
Alumina Flip Back Lens Cover - 28mm	Black	58755	030317587550
Alumina Flip Back Lens Cover - 24mm	Black	114756	030317147563
Alumina Flip Back Lens Cover - 20mm	Black	59030	030317590307
Alumina Flip Back Lens Cover - Standard EP	Black	59055	030317590550
Alumina Flip Back Lens Cover - Ultralight EP	Black	59060	030317590604
Alumina Flip Back Lens Cover - Large EP	Black	117611	030317176112
Alumina Flip Back Lens Cover Kit - 40mm & Standard EP	Black	62990	030317629908
Alumina Flip Back Lens Cover Kit - 50mm & Standard EP	Black	62995	030317629953
Mark 4 Base Torque Wrench	Black	48701	030317487010
Anti-Reflection Device (pre-2004)	Black	52292	030317522926
Anti-Reflection Device - 30mm	Black	62870	030317628703
Anti-Reflection Device - 36mm	Black	62875	030317628758
Anti-Reflection Device - 40mm	Black	62880	030317628802
Anti-Reflection Device - 50mm	Black	62885	030317628857
Anti-Reflection Device - 60mm	Black	62955	030317629557
Mark 6 Throw Lever Matte	Black	119423	030317005399
Throw Lever Kit, VX-5HD, VX-6HD	Black	172369	030317013882
Binocular Tripod Adapter	Black	118660	030317004132
Leupold Fix-It Sticks Tactical Kit	Black	170567	030317009731
Leupold Fix-It Sticks Hunter Kit	Green	170601	030317010768
Leupold DECAL Vertical 5"	White	172618	030317014605
Leupold DECAL Horizontal 12"	White	172619	030317014957
Leupold DECAL Windshield 31"	White	172620	030317014520

# 4 STEP MOUNTING SYSTEM GUIDE

1

## **FIT BASE TO RIFLE**

Determine which mounts will fit your rifle by using the chart.

Rifleman Mounts and DeltaPoint Pro Mounts are shown at the end of this section.

2

## **CHOOSE A MOUNT TYPE**

Determine a mount type based on features. Example; STD (adjustable windage), Dual Dovetail, Quick Release, BackCountry, or Cross-slot.

3

## **MATCH RING HEIGHT TO OBJECTIVE DIAMETER**

Determine the height of the rings required to mount your scope based on the front objective diameter of the scope, profile of the rifle barrel, and the type of rifle action. The goal is to have the objective of the scope as close as possible to the barrel without touching.

4

## **FIT RING DIAMETER TO MAINTUBE DIAMETER**

Determine the ring diameter required to fit the scope maintube diameter. Example; you would need a set of 30mm rings to mount a scope with a 30mm maintube diameter.

**1**

# CHOOSE A MOUNT TYPE

## STD™ (STANDARD™)

Strike-Forged steel rings  
Traditional hunting style

Adjustable windage feature  
For standard calibers less than .300 Win Mag



## DD™ (DUAL DOVETAIL™)

Strike-Forged steel rings  
Traditional hunting style

Standard to magnum calibers



## QR™ (QUICK RELEASE™)

Strike-Forged steel rings  
Traditional hunting style  
Quick release & reattach feature

Standard to magnum calibers



## CROSS-SLOT

PRW2™ (Perma-Rings  
Weaver Style™)  
QRW2™ (Quick Release  
Weaver Style)

LRW™ (Leupold Rings  
Weaver Style™)  
Standard to magnum calibers



## BACKCOUNTRY

Lightweight 7075 aircraft-grade aluminum  
Available in cross-slot and one-piece integrated styles

Standard to magnum calibers  
Long range MOA bases



## RINGMOUNTS

Fits integral rifle receivers & rails  
Rimfire (11mm, 13mm & 3/8")

CZ, Ruger & Sako models  
Standard to magnum calibers



## MARK 4®

Strike-Forged steel & aircraft-grade aluminum rings  
Cross-slot style

Long range MOA bases  
Standard to magnum calibers



## IMS™ (INTEGRAL MOUNTING SYSTEM®)

For modern sporting rifles  
Correct height with forward cantilever

Aircraft-grade aluminum  
Standard to magnum calibers



# 2

# FIT BASE TO RIFLE

Firearm Base Model	Base Part Number		
	Gloss	Matte	Silver
<b>Antonio Zoli</b>			
QR Antonio Zoli	-	51344	-
<b>AR / Flattop</b>			
IMS (Integral Mounting System) Mounts see chart at the end of Section 2			
<b>Barret Fieldcraft</b>			
BackCountry Cross-Slot SA 20 MOA 1-Pc	-	175647	-
BackCountry Cross-Slot LA 20 MOA 1-Pc	-	175648	-
<b>Browning</b>			
1885 High Wall (not for use with the 1885 BPCR)			
STD 1885 HW 2-Pc	50012	-	-
1885 Low Wall			
STD 1885 LW 2-Pc	51260	-	-
A-Bolt (Long Action)			
STD A-Bolt 1-Pc	-	50010	-
STD A-Bolt LR 2-Pc	50029	50030	50031
STD A-Bolt 2-Pc	50036	-	-
DD A-Bolt RVF 2-Pc	-	50159	57537
QR A-Bolt 2-Pc	-	50057	-
QRW / PRW A-Bolt 2-Pc	-	49847	-
BackCountry Cross-Slot A-Bolt 1-Pc	-	171346	-
BackCountry Cross-Slot A-Bolt 1-Pc 20-MOA	-	171347	-
Mark 4 A-Bolt LA 20-MOA 1-Pc	-	170751	-
A-Bolt (Short Action)			
STD A-Bolt 1-Pc	-	50008	-
STD A-Bolt LR 2-Pc	50029	50030	50031
STD A-Bolt 2-Pc	50036	-	-
DD A-Bolt RVF 2-Pc	-	50159	57537
QR A-Bolt 2-Pc	-	50057	-
QRW / PRW A-Bolt 2-Pc	-	49847	-
BackCountry Cross-Slot A-Bolt 1-Pc	-	171344	-
BackCountry Cross-Slot A-Bolt 1-Pc 20-MOA	-	171345	-
Mark 4 A-Bolt SA 20-MOA 1-Pc	-	170750	-
A-Bolt (Short Action)			
STD A-Bolt Shotgun 2-Pc	-	118395	-

Firearm Base Model	Base Part Number		
	Gloss	Matte	Silver
A-Bolt WSSM (including 2005 and later .223 Rem. & .204 Rug. rifles)			
STD A-Bolt WSSM 2-Pc	57330	57340	57350
QR A-Bolt WSSM 1-Pc	61010	60790	60660
AB3			
STD AB3 RVR 2-Pc	-	120128	-
DD AB3 RVR 2-Pc	-	172051	-
QR AB3 RVR 2-Pc	-	172052	-
QRW/PRW AB3 2-Pc	-	174313	-
BackCountry RM* AB3 2-Pc 1" Medium	-	171104	-
BackCountry RM* AB3 2-Pc 1" High	-	171105	-
BackCountry RM* AB3 2-Pc 30mm Medium	-	171118	-
BackCountry RM* AB3 2-Pc 30mm High	-	171119	-
BackCountry Cross-Slot AB3 SA 1-Pc	-	174682	-
BackCountry Cross-Slot AB3 SA 20 MOA 1-Pc	-	174683	-
BackCountry Cross-Slot AB3 LA 1-Pc	-	174684	-
BackCountry Cross-Slot AB3 LA 20 MOA 1-Pc	-	174685	-
Auto (also Benelli Argo and R1)			
STD BAR 1-Pc	49985	178121	-
QR BAR 1-Pc	51249	179106	-
QR BAR 2-Pc	-	51223	-
Euro-Bolt II			
STD BR-European 2-Pc	50032	-	-
FN Action see Mauser FN			
BLR (Model 81, Pre-1996)			
STD BLR 1-Pc	49986	-	178122
BLR Lightning			
STD BLR Lightning 2-Pc	50237	50238	-
Micro Medallion			
STD A-Bolt SA 1-Pc	-	50008	-
STD A-Bolt LR 2-Pc	50029	50029	50031
STD A-Bolt 2-Pc	50036	-	-
DD A-Bolt RVF 2-Pc	-	50159	57537
QR A-Bolt 2-Pc	-	50057	-
QRW / PRW A-Bolt 2-Pc	-	49847	-
Semi-Auto .22 RF Rifle			
DD BR S-A RF 1-Pc	50014	-	-

STD	Dual Dovetail	QR	Cross-Slot	Ringmount	Backcountry	Tactical
-----	---------------	----	------------	-----------	-------------	----------

2

# FIT BASE TO RIFLE CONT.

Firearm Base Model	Base Part Number		
	Gloss	Matte	Silver
<b>T-Bolt</b>			
STD 541 2-Pc	50028	-	-
QR 541 2-Pc	52240	52239	-
QRW / PRW 541 2-Pc	49866	-	-
<b>X-Bolt</b>			
STD X-Bolt 2-Pc	65424	65416	65425
DD X-Bolt 2-Pc	65414	65413	65415
QR X-Bolt 2-Pc	66075	66080	66085
BackCountry RM* X-Bolt 2-Pc 1" Medium	-	171108	-
BackCountry RM* X-Bolt 2-Pc 1" High	-	171109	-
BackCountry RM* X-Bolt 2-Pc 30mm Medium	-	171122	-
BackCountry RM* X-Bolt 2-Pc 30mm High	-	171103	-
BackCountry Cross-Slot Browning X-Bolt SA 1-pc	-	176394	-
BackCountry Cross-Slot Browning X-Bolt SA 1-pc 20 MOA	-	176395	-
BackCountry Cross-Slot Browning X-Bolt LA 1-pc	-	176396	-
BackCountry Cross-Slot Browning X-Bolt LA 1-pc 20 MOA	-	176397	-
<b>BSA</b>			
BSA Monarch (Rt. Hand, Long Action) see Remington 700 (Rt. Hand, Long Action)			
BSA Monarch (Rt. Hand, Short Action) see Remington 700 (Rt. Hand, Short Action)			
<b>Christensen Arms</b>			
Mesa, Ridgeline see Remington 700 2-Pc			
<b>Cooper</b>			
Cooper 16, 22, 23, 52, 56 & 92			
STD Cooper 16/22/23 2-Pc	-	50234	-
Cooper 21, 38 & 57			
STD Cooper 21/38 2-Pc	-	52980	-
<b>CVA</b>			
CVA			
QR CVA 2-Pc	-	52324	-
<b>CZ</b>			
CZ 527			
RM CZ 527 1" Medium (1.00")	-	54360	-
RM CZ 527 1" High (1.10")	-	62001	-
RM CZ 527 30mm Medium (1.00")	-	61666	-
RM CZ 527 30mm High (1.10")	-	61830	-
CZ 550 & CZ 557			
RM CZ 527 1" Medium (1.00")	-	54350	-
RM CZ 527 1" High (1.10")	-	61750	-
RM CZ 527 30mm Medium (1.00")	-	61885	-
RM CZ 527 30mm High (1.10")	-	61790	-

Firearm Base Model	Base Part Number		
	Gloss	Matte	Silver
<b>Dakota</b>			
Dakota 76			
QR 70 Exp Pre-64 2-Pc	-	50062	-
QRW / PRW 70 Exp Pre-64 2-Pc	-	49836	-
<b>Harrington &amp; Richardson</b>			
Harrington & Richardson 300, 301, 330, 370: Pre-1973 see Mauser FN			
<b>Husqvarna</b>			
Husqvarna Carl Gustaf & Crown Grade (also J.C. Higgins Post 1955)			
STD HC 1-Pc	49989	-	-
<b>Howa, Interarms</b>			
1500 see Weatherby Vanguard			
<b>J.C. Higgins</b>			
J.C. Higgins Post 1955 see Husqvarna			
J.C. Higgins Post 1955 see Husqvarna			
<b>Kimber</b>			
Kimber 84 (2004 models and newer)			
STD 84 2-Pc	-	56859	-
DD 84 2-Pc	-	60910	-
BackCountry Cross-Slot Kimber 84M SA 1-pc	-	176390	-
BackCountry Cross-Slot Kimber 84M SA 20 MOA	-	176391	-
Kimber 8400 (2004 models and newer)			
STD 8400 RVF 2-Pc	-	56928	-
DD 8400 RVF 2-Pc	-	60760	-
QR 8400 2-Pc	-	64015	-
BackCountry Cross-Slot Kimber 8400 Magnum LA 1-pc	-	176392	-
BackCountry Cross-Slot Kimber 8400 Magnum LA 1-pc 20 MOA	-	176393	-
<b>Knight</b>			
Knight DISC LK93 & KRB, & Wolverine see Remington 541			
STD 541 2-Pc	50028	-	-
QR 541 2-Pc	52240	52239	-
QRW / PRW 541 2-Pc	49866	-	-
<b>Marlin</b>			
Marlin MR 7 & MR 7B (Rt. Hand, Long Action) see Winchester 70 (Rt. Hand, Long Action)			
Marlin MR 7 (Rt. Hand, Short Action) see Winchester 70 (Rt. Hand, Short Action)			
Marlin 336, 336T, 35, 36, 36A, 375, 444, 1895, 9, 45, 30AS, 922M, & XLR			
STD 1895/336 1-Pc	49987	178127	-
QR 1895/336 1-Pc	-	54229	54277
Marlin 455 see Mauser FN			

STD

Dual Dovetail

QR

Cross-Slot

Ringmount

Backcountry

Tactical





# FIT BASE TO RIFLE CONT.

Firearm Base Model	Base Part Number		
	Gloss	Matte	Silver
<b>Mauser</b>			
Mauser FN (also Browning FN .264 through .458, Harrington & Richardson 300, 301, 330, 370 Pre-1973, J.C. Higgins Pre-1955, Marlin 455, Mauser M12, Mauser Mark X, Parker Hale 100, 1100, 1200, Remington Model 798, Sako Round Receiver, and Weatherby FN)			
STD FN 1-Pc	49988	178124	-
STD FN 2-Pc	50025	50026	-
STD FN RVF 2-Pc	50027	-	-
QR FN 2-Pc	50055	50056	-
Mauser Mark X (Interarms) see Mauser FN			
Mauser 98 and similar models (Large Ring) (Ring heights are based upon original configuration and may vary according to custom configurations; firearm may require modification)			
STD M 98 1-Pc	49990	178123	-
STD M 98 2-Pc	-	52370	-
Mauser 96, 38, and similar models (Small Ring) (Ring heights are based upon original configuration and may vary according to custom configurations; firearm may require modification)			
STD M 96 2-Pc	-	51263	-
<b>Mossberg</b>			
Mossberg 1500/1700/ATR (Rt. Hand, Long Action) see Remington 700 (Rt. Hand, Long Action)			
Mossberg 1500/1700/ATR (Rt. Hand, Short Action) see Remington 700 (Rt. Hand, Short Action)			
<b>Nosler</b>			
All Remington 700 2-Pc fit Nosler M48. See Remington 700 2-Pc			
BackCountry Cross-Slot M48 SA 1-Pc	-	175217	-
BackCountry Cross-Slot M48 SA 1-Pc 20-MOA	-	175218	-
BackCountry Cross-Slot M48 LA 1-Pc	-	175219	-
BackCountry Cross-Slot M48 LA 1-Pc 20-MOA	-	175220	-
<b>Parker Hale</b>			
Parker Hale 1000, 1100, 1200 see Mauser FN			
<b>Remington</b>			
Remington Model 4, 6, 7400, & 7600			
STD 7400/7600 1-Pc	49993	53056	-
QR 7400/7600 1-Pc	50067	-	-

Firearm Base Model	Base Part Number		
	Gloss	Matte	Silver
Remington Model 7 (for use with any Remington Model 7)			
STD 700 RH-SA 1-Pc	50005	50006	50161
STD 700 Long Range RH-SA 1-Pc	-	51734	-
QR 700 RH-SA 1-Pc	-	51247	-
BackCountry Cross-Slot Rem Mod 7 1-Pc	-	175922	-
BackCountry Cross-Slot Rem Mod 7 1-Pc 20-MOA	-	175923	-
Remington Model 7 (serial number higher than 762,800 on stainless models or 773,800 on blue finished models)			
STD 700 RH-SA 1-Pc 50005 50006 50161	50005	50006	50161
STD 700 Long Range RH-SA 1-Pc	-	51734	-
STD Model 7 2-Pc	51256	51277	51257
QR 700 RH-SA 1-Pc	-	51247	-
DD XP-100 1-Pc	-	53570	-
Remington 541 (also Knight DISC, LK93 & KRB, & Wolverine)			
STD 541 2-Pc	50028	-	-
QR 541 2-Pc	-	52239	-
QRW / PRW 541 2-Pc	49866	-	-
Remington 597			
STD 597 1-Pc	-	53050	53052
Remington 600/660 and 673 Guide Rifle			
STD 700 RH-SA 1-Pc	50005	50006	50161
STD 700 Long Range RH-SA 1-Pc	-	51734	-
QR 700 RH-SA 1-Pc	-	51247	-
DD XP-100 1-Pc	-	53570	-
All Remington 700, 721, 725, 40X. Two-Piece Bases			
STD 700 2-Pc	50015	50016	57510
STD 700 RVF 2-Pc	50017	50018	50019
DD 700 2-Pc	50041	50042	51727
DD 700 RVF 2-Pc	-	50044	-
QR 700 2-Pc	50049	50050	50059
QRW / PRW 700 2-Pc	49840	49841	49842
BackCountry RM* 700 2-Pc 1" Medium	-	171098	-
BackCountry RM* 700 2-Pc 1" High	-	171099	-
BackCountry RM* 700 2-Pc 30mm Medium	-	171112	-
BackCountry RM* 7002-Pc 30mm High	-	171113	-
Mark 4 Remington 700 2-pc	-	59230	-

\* BackCountry RM (Ringmount) Fits Rt. Hand or Lt. Hand Actions



# 2

# FIT BASE TO RIFLE CONT.

Firearm Base Model	Base Part Number		
	Gloss	Matte	Silver
Remington 700/721/725 (Rt. Hand, Long Action) (also BSA Monarch, Mossberg 1500/1700, Ruger M77 Round Receiver, Smith and Wesson 1500 Rifle, & Tar Hunt RSG 12/20, Weatherby Mark V 2-pc)			
STD 700 RH-LA 1-Pc	50003	50004	-
STD 700 Long Range RH-LA 1-Pc	-	51732	51733
BackCountry Cross-Slot 700 LA 1-Pc	-	171334	-
BackCountry Cross-Slot 700 LA 1-Pc 20-MOA	-	171335	-
Mark 4 Remington 700 LA 1-pc 20 MOA	-	170749	-
Remington 700/721/725 (Lt. Hand, Long Action)			
STD 700 LH-LA 1-Pc	50007	-	-
Mark 4 Remington 700 LA 1-pc 20 MOA	-	170749	-
Remington 700/721/725 (Rt. Hand, Short Action) (also BSA Monarch, Mossberg 1500/1700, Remington 700 Muzzleloader, & Ruger M77 Round Receiver)			
STD 700 RH-SA 1-Pc	50005	50006	50161
STD 700 Long Range RH-SA 1-Pc	-	51734	-
QR 700 RH-SA 1-Pc	-	51247	-
DD XP-100 1-Pc	-	53570	-
BackCountry Cross-Slot 700 SA 1-Pc	-	171332	-
BackCountry Cross-Slot 700 SA 1-Pc 20-MOA	-	171333	-
Mark 4 Remington 700 SA 1-pc 20 MOA	-	170744	-
Remington 700/721/725 (Lt. Hand, Short Action)			
Mark 4 Remington 700 LA 1-pc 20 MOA	-	170749	-
Remington 40X (Long Action)			
STD 700 RH-LA 1-Pc	50003	50004	-
STD 700 Long Range RH-LA 1-Pc	-	51732	51733
Mark 4 Remington 700 LA 1-pc 20 MOA	-	170749	-
BackCountry Cross-Slot 700 LA 1-Pc	-	171334	-
BackCountry Cross-Slot 700 LA 1-Pc 20-MOA	-	171335	-
Remington 40X (Short Action)			
STD 700 RH-SA 1-Pc	50005	50006	50161
STD 700 Long Range RH-SA 1-Pc	-	51734	-
QR 700 RH-SA 1-Pc	-	51247	-
DD XP-100 1-Pc	-	53570	-
Mark 4 Remington 700 SA 1-pc 20 MOA	-	170744	-
BackCountry Cross-Slot 700 SA 1-Pc	-	171332	-
BackCountry Cross-Slot 700 SA 1-Pc 20-MOA	-	171333	-
Remington 700 Muzzleloader see Remington 700 (Rt. Hand, Short Action)			
Remington 710 & 770			
STD 710 2-Pc	-	54100	-

Firearm Base Model	Base Part Number		
	Gloss	Matte	Silver
Remington 740, 742, & 760			
STD 760 1-Pc	49992	178120	-
Remington 750			
STD 7400/7600 1-Pc	49993	-	-
Remington 783			
STD 10/110 Round Receiver 2-Pc	55741	55742	55743
DD 10/110 Round Receiver 2-Pc	-	114975	-
QR 10/110 Round Receiver 2-Pc	-	55761	-
BackCountry Cross-Slot 783 SA 1-Pc	-	175971	-
BackCountry Cross-Slot 783 SA 1-Pc 20-MOA	-	175972	-
BackCountry Cross-Slot 783 LA 1-Pc	-	175973	-
BackCountry Cross-Slot 783 LA 1-Pc 20-MOA	-	175974	-
Mark 4 10/110 Round Receiver 2-Pc	-	59245	-
Remington 799			
STD 799 RH-SA 1-Pc	64005	-	64010
Remington XP-100 (for use with any Remington XP-100)			
STD 700 RH-SA 1-Pc	50005	50006	50161
STD 700 Long Range RH-SA 1-Pc	-	51734	-
QR 700 RH-SA 1-Pc	-	51247	-
DD XP-100 1-Pc	-	53570	-
Remington XP-100 R (new model with four mounting holes)			
STD 700 RH-SA 1-Pc	50005	50006	50161
STD Model 7 2-Pc	51256	57277	51257
STD 700 Long Range RH-SA 1-Pc	-	51734	-
QR 700 RH-SA 1-Pc	-	51247	-
DD XP-100 1-Pc	-	53570	-
<b>Rimfire</b>			
Rimfire (for use with 11mm dovetail rail)			
RM Rimfire 11mm Medium (0.87")	54231	178114	-
RM Rimfire 11mm High (1.00")	54234	178115	-
Rimfire (for use with 13mm dovetail rail)			
RM Rimfire 13mm (1/2") Low (0.72")	49949	178118	-
RM Rimfire 13mm (1/2") Medium (0.84")	49947	178119	-
Rimfire (for use with 3/8 inch dovetail rail)			
RM Rimfire 3/8 inch Medium (0.85")	54289	178116	-
RM Rimfire 3/8 inch High (0.98")	54286	178117	-

- STD
- Dual Dovetail
- QR
- Cross-Slot
- Ringmount
- Backcountry
- Tactical



# FIT BASE TO RIFLE CONT.

Firearm Base Model	Base Part Number		
	Gloss	Matte	Silver
<b>Ruger</b>			
Ruger American			
STD Ruger Am. 2-Pc	-	171903	-
STD Ruger Am. RVR 2-Pc	-	120092	-
D Ruger Am. Rimfire 2-Pc	-	170489	-
DD Ruger Am. RVR 2-Pc	-	171901	-
BackCountry Cross-Slot Ruger Am. SA 1-Pc	-	171358	-
BackCountry Cross-Slot Ruger Am. SA 1-Pc 20-MOA	-	171359	-
BackCountry Cross-Slot Ruger Am. LA 1-Pc	-	171360	-
BackCountry Cross-Slot Ruger Am. LA 1-Pc 20-MOA	-	171361	-
Ruger Number 1, 77/22, 77/44, 77/357, 96/44, Mini 14/30 with integral mount			
RM Ruger No. 1 - 1" Low (0.73")	49950	-	-
RM Ruger No. 1 - 1" High (1.15")	50216	50217	-
RM Ruger No. 1 Extension - 1" Medium (1.03)	-	52306	-
RM Ruger No. 1 Extension - 1" High (1.15")	-	52307	-
RM Ruger No. 1 Extension - 1" Super High (1.28")	-	52308	-
RM Ruger No. 1 - 30mm Medium (1.03)	-	51038	-
RM Ruger No. 1 - 30mm High (1.15")	-	51039	-
Ruger 10/22			
STD 10/22 1-Pc	49994	51723	51724
BackCountry Cross-Slot Ruger 10/22 1-pc 20 MOA	-	176389	-
Ruger M77 (Round Receiver, Rt. Hand, Long Action) see Remington 700 (Rt. Hand, Long Action)			
Ruger M77 (Dovetail Receiver, Long Action & Short Action)			
RM Ruger M77 - 1" Medium (0.90")	-	170351	-
RM Ruger M77 - 1" High (1.03")	49951	49952	49953
RM Ruger M77 - 1" Super High (1.15")	49954	49944	50166
RM Ruger M77 Extension - 1" High (1.03")	-	52301	-
RM Ruger M77 Extension - 1" Super High (1.15")	-	52302	-
RM Ruger M77 - 30mm Medium (0.90")	-	51041	-
RM Ruger M77 - 30mm High (1.03")	-	51042	-
RM Ruger M77 - 30mm Super High (1.15")	-	51043	-
RM Ruger M77 Extension - 30mm High (1.03")	-	52304	-
RM Ruger M77 Extension - 30mm Super High (1.15")	-	52305	-
Ruger Mini 14 (Drilling and Tapping Required)			
STD Mini 14 1-Pc	50002	-	-

Firearm Base Model	Base Part Number		
	Gloss	Matte	Silver
<b>Sako</b>			
Sako (Round Receiver) see Mauser FN			
Sako (Tapered Dovetail Receiver) (not for use with the Sako Finnfire or other Sako .22 rimfire rifles)			
QR Sako 2-Pc	53064	53066	-
RM Sako - 1" Low (0.76")	49946	-	-
RM Sako - 1" Medium (0.86")	49945	54409	51719
RM Sako - 1" High (1.06")	49948	54410	51720
RM Sako - 1" Super High (1.16")	49942	49943	-
RM Sako - 30mm Medium (0.86")	-	51036	-
RM Sako - 30mm High (1.06")	-	51037	-
RM Sako - 30mm Super High (1.16")	-	51722	-
<b>Sauer</b>			
Sauer 90/200			
QR 90/200 2-Pc	-	50061	-
Sauer 202			
QR 202 2-Pc	50215	-	-
BackCountry Cross-Slot 202 SA 1-Pc 20-MOA	-	171356	-
BackCountry Cross-Slot 202 LA 1-Pc 20-MOA	-	171357	-
<b>Savage</b>			
Savage all 10 - 16 and 110 - 116 Round Rear Receiver, Axis			
STD 10/110 Round Receiver 2-Pc	55741	55742	55743
DD 10/110 Round Receiver 2-Pc	-	114975	-
QR 10/110 Round Receiver 2-Pc	-	55761	-
QRW / PRW 10/110 Round Receiver 2-Pc	-	171707	-
Mark 4 10/110 Round Receiver 2-Pc	-	59245	-
BackCountry RM* 10/110 2-Pc 1" Medium	-	171100	-
BackCountry RM* 10/110 2-Pc 1" High	-	171101	-
BackCountry RM* 10/110 2-Pc 30mm Medium	-	171114	-
BackCountry RM* 10/110 2-Pc 30mm High	-	171115	-
Savage all 10 - 16 and 110 - 116 Flat Rear Receiver			
QR 110 2-Pc	52314	-	-
QRW/PRW 110 2-Pc	49833	-	-
Savage 110 through 116 Round Rear Receiver (Rt. Hand, Long Action)			
STD 110 RH-LA Round Receiver 1-Pc	55701	178125	55705
BackCountry Cross-Slot 110/AXIS LA 1-Pc	-	171338	-

- STD
- Dual Dovetail
- QR
- Cross-Slot
- Ringmount
- Backcountry
- Tactical

# 2

# FIT BASE TO RIFLE CONT.

MOUNTING SYSTEMS

Firearm Base Model	Base Part Number		
	Gloss	Matte	Silver
Savage 10 through 16 Round Rear Receiver (Rt. Hand, Short Action)			
STD 10 RH-SA Round Receiver 1-Pc	55721	55724	-
BackCountry Cross-Slot 10 SA 1-Pc	-	171336	-
BackCountry Cross-Slot 10 SA 1-Pc 20-MOA	-	171337	-
Savage 110 through 116 Round Rear Receiver (Lt. Hand, Long Action)			
STD 10 LH-LA Round Receiver 1-Pc	55711	-	-
Savage 10 through 16 Round Rear Receiver (Lt. Hand, Short Action)			
TD 10 LH-SA Round Receiver 1-Pc	55731	-	-
Savage 110 through 116 Flat Rear Receiver (Rt. Hand, Long Action)			
STD 110 RH-LA 1-Pc	49996	-	-
Savage 10 through 16 Flat Rear Receiver (Rt. Hand, Short Action)			
STD 10 RH-SA 1-Pc	-	52317	52318
Savage 110 through 116 Flat Rear Receiver (Lt. Hand, Long Action)			
STD 110 LH-LA 1-Pc	50219	-	-
Savage 110 through 116 Flat Rear Receiver (Lt. Hand, Short Action)			
STD 10 LH-SA 1-Pc	52326	-	-
Savage 99			
STD 99 1-Pc	49995	178126	-
<b>Smith and Wesson</b>			
Smith and Wesson Rifle (Early Model)			
STD HC 1-Pc	49989	-	-
Smith and Wesson 1500 (Rt. Hand, Long Action) see Remington 700 (Rt. Hand, Long Action)			
Springfield 1903 A3			
STD 1903 A3 1-Pc	49997	178128	-
<b>Steyr</b>			
Steyr SBS Safe Bolt Pro Hunter & Forester			
STD A-Bolt LR 2-Pc	50029	50030	50031
STD A-Bolt 2-Pc	50036	-	-
DD A-Bolt RVF 2-Pc	-	50159	57537
QR A-Bolt 2-Pc	-	50057	-
QRW / PRW A-Bolt 2-Pc	49846	49847	-
QR Steyr / Mannlicher 2-Pc	-	60656	-
Tar Hunt RSG 12 & RSG 20 see Remington 700 (Rt. Hand, Long Action)			
<b>Thompson / Center</b>			
Thompson / Center Contender			
DD T/C-C 1-Pc	53556	-	53558
QR T/C-C 1-Pc	50068	-	-

Firearm Base Model	Base Part Number		
	Gloss	Matte	Silver
Thompson / Center Encore & Omega, Pro Hunter FX			
DD T/C Encore 1-Pc	-	54218	54798
QR T/C Encore 1-Pc	-	52325	57496
<b>Tikka</b>			
Tikka T3 / T3x			
STD Tikka T3x 2-Pc	-	54447	-
DD Tikka T3x 2-Pc	-	170384	-
QR Tikka T3x 2-Pc	-	114976	-
QRW T3/T3x 2-Pc Matte	-	170029	-
BackCountry RM* T3/T3x 2-Pc 1" Medium	-	171102	-
BackCountry RM* T3/T3x 2-Pc 1" High	-	171103	-
BackCountry RM* T3/T3x 2-Pc 30mm Med.	-	171116	-
BackCountry RM* T3/T3x 2-Pc 30mm High	-	171117	-
BackCountry Cross-Slot T3/T3x 1-Pc	-	171348	-
BackCountry Cross-Slot T3/T3x 1-Pc 20-MOA	-	171349	-
Mark 4 T3/T3x 20 MOA 1-Pc	-	170753	-
Traditions Lightning & Buckhunter & Remington Genesis			
QR Traditions 2-Pc	-	52315	-
<b>Weatherby</b>			
Weatherby FN see Mauser FN			
Weatherby Mark V Magnum (9 Lug) & Vanguard			
STD MK V 2-Pc	51700	51701	-
STD MK V RVF 2-Pc	51702	51703	51704
DD MK V 2-Pc	51705	51706	-
DD MK V RVF 2-Pc	-	51707	-
QR MK V 2-Pc	-	51709	-
QRW / PRW MK V 2-Pc	-	171709	-
BackCountry RM* MK V 2-Pc 1" Medium	-	171110	-
BackCountry RM* MK V 2-Pc 1" High	-	171111	-
BackCountry RM* MK V 2-Pc 30mm Medium	-	171124	-
BackCountry RM* MK V 2-Pc 30mm High	-	171125	-
BackCountry Cross-Slot MK V/Vanguard LA 1-Pc	-	171354	-
BackCountry Cross-Slot MK V/Vanguard LA 1-Pc 20-MOA	-	171355	-
BackCountry Cross-Slot Vanguard SA 1-Pc	-	171514	-
BackCountry Cross-Slot Vanguard SA 1-Pc 20-MOA	-	171515	-
Mark 4 MK V LA, 20-MOA 1-Pc	-	171500	-
Mark 4 Vanguard SA, 20-MOA 1-Pc	-	171498	-

STD	Dual Dovetail	QR	Cross-Slot	Ringmount	Backcountry	Tactical
-----	---------------	----	------------	-----------	-------------	----------



# FIT BASE TO RIFLE CONT.

Firearm Base Model	Base Part Number		
	Gloss	Matte	Silver
Weatherby MK V Lightweight & .240 Wby Mag., (6 Lug)			
STD Mark V LW 2-Pc	52319	52507	-
Mark 4 MK V SA, 20-MOA 1-Pc	-	171499	-
BackCountry Cross-Slot MK V LT 1-Pc	-	171352	-
BackCountry Cross-Slot MK V LT 1-Pc 20-MOA	-	171353	-
<b>Western Field M7-40</b>			
STD 336R 1-Pc	49987	-	-
<b>Winchester</b>			
Winchester 70 WSSM			
STD 70 WSSM 2-Pc	57300	57310	-
QR 70 WSSM 1-Pc	61030	60990	60880
Winchester 70, 670, 770, & 70A (Long Action) Fits post war non-Express models (serial number higher than 66,360)			
STD 70A 1-Pc	50000	50001	-
STD 70 Long Range RH-LA 1-Pc	-	51736	51737
STD 70 RVR 2-Pc	50020	50021	-
STD 70 RVF/R 2-Pc	50022	50023	50024
DD 70 2-Pc	50045	50046	57286
DD 70 RVF 2-Pc	-	54241	-
QR 70 2-Pc	50053	50054	-
QRW / PRW 70 2-Pc	-	49838	-
BackCountry RM* 70 2-Pc 1" Medium	-	171106	-
BackCountry RM* 70 2-Pc 1" High	-	171107	-
BackCountry RM* 70 2-Pc 30mm Medium	-	171120	-
BackCountry RM* 70 2-Pc 30mm High	-	171121	-
BackCountry Cross-Slot 70 LA 1-Pc	-	171342	-
BackCountry Cross-Slot 70 LA 1-Pc 20-MOA	-	171343	-
Mark 4 70 2-Pc	-	59240	-
Winchester 70, 670, 770, & 70A (Short Action) Fits post war non-Express models (serial number higher than 66,360)			
STD 70 Long Range RH-SA 1-Pc	-	51738	-
STD 70 RVR 2-Pc	50020	50021	-
STD 70 RVF/R 2-Pc	50022	50023	50024
DD 70 2-Pc	50045	50046	57286
DD 70 RVF 2-Pc	-	54241	-
QR 70 2-Pc	50053	50054	-

\* BackCountry RM (Ringmount) Fits Rt. Hand or Lt. Hand Actions

Firearm Base Model	Base Part Number		
	Gloss	Matte	Silver
QRW / PRW 70 2-Pc	-	49838	-
BackCountry Cross-Slot 70 SA 1-Pc	-	171340	-
BackCountry Cross-Slot 70 SA 1-Pc 20-MOA	-	171341	-
Mark 4 70 2-Pc	-	59240	-
Winchester 70 Express Pre-1964 (.435 Rear Mount Hole Spacing for .458 Win., .416 Rem., .375 H&H, .300 Weatherby, and .300 H&H magnums)			
QR 70 Exp Pre-64 2-Pc	-	50062	-
QRW / PRW 70 Exp Pre-64 2-Pc	-	49836	-
Winchester 70 Express Post 1964 (.330 Rear Mount Hole Spacing for .458 Win., .416 Rem., .375 H&H, .300 Weatherby, .300 H&H magnums, and 7mm STW)			
STD 70 Exp RVF 2-Pc	50377	50378	50379
DD 70 Exp Post-1964 RVF 2-Pc	-	54240	-
QR 70 Exp Post-64 2-Pc	-	50063	-
QRW / PRW 70 Exp Post-64 2-Pc	-	49835	-
Winchester 94 AE (except for big bore applications)			
STD 94 2-Pc	50035	-	-
Winchester 1885 High Wall Hunter & Traditional Hunter			
STD 1885 HW 2-Pc	50012	-	-
Winchester 1885 High Wall .22 cal			
STD 1885 HW 2-Pc	50012	-	-
Winchester 1885 Low Wall (.17 HMR & .17 Mach 2)			
STD 1885 LW 2-Pc	51260	-	-
Winchester XPR			
STD XPR 2-Pc	-	174499	-
DD XPR 2-Pc	-	170358	-
BackCountry Cross-Slot XPR SA 1-Pc	-	174686	-
QR XPR 2-Pc	-	174495	-
QRW / PRW XPR 2-Pc	-	174436	-
BackCountry Cross-Slot XPR SA 20 MOA 1-Pc	-	174687	-
BackCountry Cross-Slot XPR LA 1-Pc	-	174688	-
BackCountry Cross-Slot XPR LA 20 MOA 1-Pc	-	174689	-





# FIT BASE TO RIFLE CONT.

Firearm Base Model	Base Part Number		
	Gloss	Matte	Silver
<b>IMS Mounts - AR / Flattop</b>			
IMS = Integral Mounting System			
Mark 1 IMS Integral Rail Mount (Rail Only)	-	110288	-
Mark 2 IMS Integral Rail Mount (Rail Only)	-	110289	-
Mark 4 AR15/M16 Handle Mount	-	52136	-
Mark 4 IMS 30mm	-	171986	-
Mark 4 IMS 30mm, 20-MOA	-	171987	-
Mark IMS 34mm	-	176882	-
Mark IMS 34mm 20 MOA	-	176883	-
Mark IMS 34mm Bolt-Action	-	176884	-
Mark IMS 34mm Bolt-Action LH	-	176915	-
Mark IMS 34mm Bolt-Action 20 MOA	-	176885	-
Mark IMS 35mm	-	176886	-
Mark IMS 35mm 20 MOA	-	176887	-
Mark IMS 35mm Bolt-Action	-	176888	-
Mark IMS 35mm Bolt-Action 20 MOA	-	176889	-
AR D-LOC For DeltaPoint Pro	-	171861	-
DeltaPoint Pro AR Mount	-	177154	-

STD

Dual Dovetail

QR

Cross-Slot

Ringmount

Backcountry

Tactical

# RIFLEMAN MOUNTING INFORMATION

Firearm Base Model	Base Part Number			Rifleman Scope		
				3-9x40	3-9x50	4-12x40
	Gloss	Matte	Silver	Maximum Ring Spacing		
				5.1 in	4.0 in	4.1 in
<b>Browning</b>						
Rifleman Browning A-Bolt (2-Piece)	-	56521	-	M**	H*	M**
Rifleman Browning AB3 (2-Piece)	-	174377	-	M**	H*	M**
<b>CVA / Traditions</b>						
Rifleman CVA & Trad. Pursuit (2-Piece)	-	56500	-	M**	H*	M**
<b>Harrington &amp; Richardson</b>						
H&R New England Muzzleloader (1-Piece)	-	56515	-	M**	H*	M**
<b>Knight LK 3</b>						
Rifleman Knight LK 93 (2-Piece)	-	56503	-	H*	H*	H*
<b>Marlin 336</b>						
Rifleman Marlin 336 (1-Piece)	-	55910	-	M**	H*	M**
<b>Remington</b>						
Rifleman 7 (2-Piece)	-	56867	-	M**	H*	M**
Rifleman Rem 700 (2-Piece)	-	55890	-	M**	H*	M**
Rifleman 7400/7600 (1-Piece)	-	56512	-	M**	H*	M**
<b>Rimfire</b>						
Rifleman .22 RF 3/8-inch Ringmount	57405	56533	-	+	+	+
Rifleman .22 RF 3/8-inch Det. See-Thru Rings	57327	57323	-	+	+	+
<b>Ruger 10/22</b>						
Rifleman 10/22 (1-Piece)	-	56506	57774	M**	H*	M**
<b>Savage 110</b>						
Rifleman Savage 110 Flat Rear Receiver (2-Piece)	-	56509	57872	M**	H*	M**
<b>Savage 10 / 110</b>						
Rifleman Savage 10/110 Round Rear Receiver 2-Pc	-	170385	-	M**	H*	M**
<b>Savage Axis / LA</b>						
Rifleman Savage Axis/LA (1-Piece)	-	120834	-	M**	H*	M**
<b>Thompson / Center encore &amp; Omega</b>						
Rifleman T/C Encore & Omega (1-Piece)	-	56518	58042	H*	H*	H*
<b>Winchester 70</b>						
Rifleman Win 70 (2-Piece)	-	55900	-	M**	H*	M**
Rifleman Win XPR (2-Piece)	-	174384	-	M**	H*	M**

Leupold Rifleman Rings	Height (in)	Finish & Part Number		
		Gloss	Matte	Silver
Vertical Split Rings	0.826	57415	55850	57420
30mm Vertical Split Rings	0.92	-	57337	-
.22 RF 3/8" Rings	0.96	57405	56533	-
.22 RF 3/8" Detachable See-Thru Rings	1.61	57327	57323	-
Detachable Low Rings	0.612	-	56524	57996
Detachable Medium Rings	0.897	57380	55860	57385
Detachable High Rings	1.147	57390	55870	57833
30mm Detachable Medium Rings	0.90	-	171478	-
30mm Detachable High Rings	1.15	-	171479	-
Detachable See-Thru High Rings	1.440	57395	55880	57400

Machined from lightweight aircraft-grade aluminum. Bases fit most rifle models; matched with your choice of detachable or vertical split rings in low, medium, or high.



\* Rifleman Detachable See-Thru Rings — Gloss (57395), Matte (55880), or Silver (57400) may also be used

\*\* Rifleman Detachable See-Thru Rings — Gloss (57395), Matte (55880), Silver (57400); Rifleman Vertical Split Rings — Matte (55850), or 30mm Matte (57337) may also be used

+ Symbol indicates an appropriate mount to be used with this scope

# DELTAPOINT PRO

# BASES FOR CUSTOM GUNMAKERS

## DeltaPoint Pro Accessories (All Matte Finish)

DeltaPoint Pro 1" Ring Top Mount Kit	175541
DeltaPoint Pro 30mm Ring Top Mount Kit	175550
DeltaPoint Pro 34mm Ring Top Mount Kit	175554
DeltaPoint Pro 35mm Ring Top Mount Kit	175558
DeltaPoint Pro 45° AR Mount	173236
DeltaPoint Pro AR Mount	177154
D-LOC Mount for AR and Flattop	171861
Cross Slot Mount	120056
Cross Slot Riser	120059
Rear Iron Sight	120058
Dovetail Mount, Beretta 92	170902
Dovetail Mount, CZ 75	170903
Dovetail Mount, 1911	170904
Dovetail Mount, Kimber 1911	177437
Dovetail Mount, HK	170905
Dovetail Mount, Glock	170906
Dovetail Mount, Kimber	170907
Dovetail Mount, SIG 226	170908
Dovetail Mount, SW MP	170909
Dovetail Mount, Springfield	170910
Dovetail Mount, SW Classic	170911
Dovetail Mount, SW MP Core	171203
Dovetail Mount, Ruger American .45	172783
Dovetail Mount, Ruger American 9mm	172784
Dovetail Mount, Marlin 336	172645

## Classic Gun Maker Bases

Windage (Single rear base)	50033
Dovetail (Single front or rear base)	50034

## QR Gun Maker Bases

QR Gunmaker 2-Pc (Includes front and rear bases)	50065
--	-------



**S&W MP core mounting kit**  
Actual details differ among handgun applications



**D-Loc Mount**



**DeltaPoint Pro with Iron Sight**



**Windage or Dovetail**



**QR (Quick Release)**

## COULDN'T FIND YOUR MOUNTING SYSTEM SOLUTION?

It's not over yet. Please see a store associate or call 1-800-Leupold for help with your mounting solution.



# 3

# MATCH RING HEIGHT TO OBJECTIVE DIAMETER

Ring Height (for bolt-action semi-auto hunting rifles)

Objective Size	General Fit	Exceptions
56mm	Super high	High on some bolt-action rifles
50mm	High	Super high height may be required for heavy barrel
42-45mm	Medium	45mm may require high
40mm	Low	Medium height may be required for heavy barrel
28-36mm	Low	Medium height may be required for heavy barrel
20-24mm	Super low	Low height may be required for bolt handle to clear eyepiece
VX-3L 56mm	Low	Medium height may be required for heavy barrel
VX-3L 50mm	Low	Medium height may be required for heavy barrel

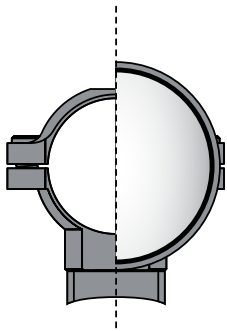

**SUPER LOW / LOW RINGS**

20mm - 40mm Objective

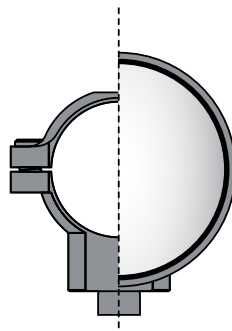

**MEDIUM RINGS**

40mm - 45mm Objective

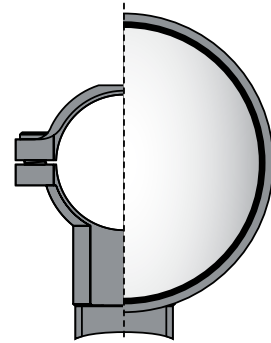

**HIGH / SUPER HIGH RINGS**

45mm - 56mm Objective

# 4

# FIT RING DIAMETER TO MAINTUBE DIAMETER

## Ring Diameter

Scope Family	VX-6HD	VX-5HD	VX-3i	VX-Freedom	Competition	FX-3	FX-I	FX-II	Mark 8	Mark 6	Mark 5HD
General Fit	30mm, 34mm	30mm	1", 30mm	1"	30mm, 34mm	1"	1"	1"	34mm, 35mm	34mm	35mm

STD RINGS	Height (in)	Gloss	Matte	Silver
GSTD 1" Super Low	0.55	-	49896	-
STD 1" Low	0.65	49897	49898	49899
STD 1" Medium	0.77	49900	49901	49902
STD 1" High	0.90	49903	49904	49905
STD 1" Super High	1.00	49906	49907	-
STD 1" Low Extension	0.65	49908	49910	-
STD 1" Medium Extension	0.77	49909	49911	-
STD 1" High Extension	0.90	49912	49913	-
STD 30mm Low	0.65	-	51718	-
STD 30mm Medium	0.77	49960	49956	52494
STD 30mm High	0.90	49961	49959	52495
STD 30mm Super High	1.00	-	51033	52496
STD 30mm Medium Extension	0.77	-	51034	-
STD 30mm High Extension	0.90	-	51035	-

DD RINGS	Height (in)	Gloss	Matte	Silver
DD 1" Super Low	0.55	-	60629	-
DD 1" Low	0.65	49914	49915	52313
DD 1" Medium	0.77	49894	49916	52323
DD 1" High	0.90	49917	49918	51730
DD 1" Super High	1.00	-	49919	-
DD 1" High Extension	0.90	-	54159	-
DD 30mm Low	0.65	-	52242	-
DD 30mm Medium	0.77	-	49957	-
DD 30mm High	0.90	-	49958	57314
DD 30mm Super High	1.00	52233	52234	-
DD 30mm High Extension	0.90	-	54186	-
DD 34mm Medium	0.77	-	173547	-
DD 34mm High	0.90	-	118283	-
DD 34mm Super High	1.00	-	118284	-

QR RINGS	Height (in)	Gloss	Matte	Silver
QR 1" Super Low	0.55	-	60976	-
QR 1" Low	0.65	49970	49971	49972
QR 1" Medium	0.77	49973	49974	49975
QR 1" High	0.90	49978	49979	49980
QR 1" Super High	1.00	-	51715	-
QR 1" Low Extension	0.65	-	60955	-
QR 1" Medium Extension	0.77	49983	49976	-
QR 1" High Extension	0.90	-	49981	-
QR 30mm Low	0.65	-	51717	-
QR 30mm Medium	0.77	49930	49931	-
QR 30mm Medium Extension	0.77	-	49939	-
QR 30mm High	0.90	49932	49933	-
QR 30mm Super High	1.00	-	51716	-
QR 30mm High Extension	0.90	-	49941	-
QR 34mm High	0.90	-	118285	-
QR 34mm Super High	1.00	-	118286	-

QRW2 RINGS	Height (in)	Gloss	Matte	Silver
QRW2 1" Low	0.73	174064	174065	174066
QRW2 1" Medium	0.85	174067	174068	174069
QRW2 1" High	0.98	174070	174071	174072
QRW2 30mm Low	0.84	174073	174074	-
QRW2 30mm Medium	0.95	174075	174076	-
QRW2 30mm High	1.07	174077	174078	-
QRW2 34mm High	-	-	177274	-

PRW2 RINGS	Height (in)	Gloss	Matte	Silver
PRW2 1" Low	0.73	-	174079	-
PRW2 1" Medium	0.85	174080	174081	-
PRW2 1" High	0.98	-	174082	-
PRW2 30mm Low	0.84	-	174083	-
PRW2 30mm Medium	0.95	-	174084	-
PRW2 30mm High	1.07	-	174085	-
PRW2 34mm Medium	1.05	-	174086	-
PRW2 34mm High	1.17	-	175860	-

LRW RINGS	Height (in)	Gloss	Matte	Silver
LRW 1" Medium	0.80	-	120974	-
LRW 1" High	0.93	-	120975	-
LRW 30mm Medium	0.80	-	120977	-
LRW 30mm High	0.93	-	120978	-

# 4

# FIT RING DIAMETER TO MAINTUBE DIAMETER CONT.

## Ring Diameter

Scope Family	VX-6HD	VX-5HD	VX-3i	VX-Freedom	Competition Series	FX-3	FX-I	FX-II	Mark 8	Mark 6	Mark 5HD
General Fit	30mm, 34mm	30mm	1", 30mm	1"	30mm	1"	1"	1"	34mm, 35mm	34mm	35mm

Mark 4 Rings	Height (in)	Matte (Aluminum)	Matte (Steel)
Mark 4 1" Medium	0.84	57524	60595
Mark 4 1" Super High	1.40	57526	60019
Mark 4 30mm Medium	0.84	57398	61049
Mark 4 30mm High	1.06	57291	60699
Mark 4 30mm Super High	1.40	57555	60750
Mark 4 34mm Medium		178530	-
Mark 4 34mm High	1.06	-	59320
Mark 4 34mm Super High	1.40	-	59310
Mark 4 35mm Medium		178531	-
Mark 4 35mm High	1.06	120180	-
Mark 4 35mm Super High	1.40	174942	-

BackCountry Cross-Slot Rings	Height (in)	Matte
BackCountry Cross-Slot Rings 1" Low	0.77	175116
BackCountry Cross-Slot Rings 1" Medium	0.90	175117
BackCountry Cross-Slot Rings 1" High	1.05	175118
BackCountry Cross-Slot Rings 30mm Low	0.89	175119
BackCountry Cross-Slot Rings 30mm Medium	0.99	175120
BackCountry Cross-Slot Rings 30mm High	1.14	175121
BackCountry Cross-Slot Rings 34mm Medium	1.07	175122
BackCountry Cross-Slot Rings 35mm High	1.09	175123

Leupold Combo Pack (1" Rings)	Height (in)	Matte	Part No.
STD Remington 700 RVF Base (2-pc)/Medium Rings	0.77		114955
STD Remington 700 RVF Base (2-pc)/High Rings	0.90		114956
STD Savage 10/110 Round Receiver Base (2-pc)/Medium Rings	0.77		114957
STD Savage 10/110 Round Receiver Base (2-pc)/High Rings	0.90		114958
STD Tikka T3/T3x Base (2-pc)/Medium Rings	0.77		178560
STD Browning X-Bolt Base (2-pc)/Medium Rings	0.77		114959
STD Winchester 70 RVR Base (2-pc)/Medium Rings	0.77		114961
STD Weatherby Mark V Base (2-pc)/Medium Rings	0.77		114963
DD Combo Packs (1" Rings)	Height (in)	Matte	
DD T/C Encore & Omega Base (1-pc)/Medium Rings	0.77		114965

Leupold Combo Pack (30mm Rings)	Height (in)	Matte	Part No.
DD Remington 700 RVF Base (2-pc)/Medium Rings			178556
DD Savage 10/110 Round Rcvr Base (2-pc)/Medium Rings			178559
DD Browning X-Bolt Base (2-pc)/Medium Rings			178557
DD Winchester 70 RVR Base (2-pc)/Medium Rings			178558
DD Tikka T3/T3x Base (2-pc)/Medium Rings			178561



# RETICLES BY MODEL

Reticles	VX-6HD	VX-6 7-42x56	VX-5HD	VX-3I	VX-3I LRP	VX-Freedom	Rifleman	VX-4.5 Service Rifle	Competition	FX	Handgun	Mark 8	Mark 8 CQBSS	Mark 6	Mark 5HD	LCO	D-EVO	DeltaPoint Pro	VX-Freedom RDS
HTMR - NEW			X																
FireDot Twilight Hunter - NEW	X																		
FireDot Bull-Ring								X											
Bull-Ring Post								X											
Tri-MOA	X					X													
Rimfire MOA						X													
UltimateSlam						X													
Combat Competition Hunting (CCH)					X						X				X				
Boone & Crockett Big Game			X	X															
Illum. Boone & Crockett Big Game	X																		
Varmint Hunter				X															
Illum. Varmint Hunter	X																		
Pig-Plex						X													
Illum. 5.56 CMR-W														X					
Illum. 7.62 CMR-W												X	X						
T-MOA			X												X				
Illum. T-MOA	X														X				
T-MOA Plus		X													X				
FireDot Duplex	X		X																
FireDot 4 Fine	X		X																
CMR-W																	X		
1 MOA Red Dot																X			X

# RETICLES BY MODEL

Reticles	VX-6HD	VX-67-4x36	VX-5HD	VX-3i	VX-3iLRP	VX-Freedom	Freedom RDS	Rifleman	VX-4.5 Service Rifle	Competition	FX	Handgun	Mark 8	Mark 8 COBSS	Mark 6	Mark 5HD	LCO	D-EVO	DeltaPoint Pro
Duplex			X	X		X					X	X							
Fine Duplex				X							X								
Wind-Plex			X	X															
Wide Duplex								X											
1/8 Min. Target Dot										X									
Impact-14 MOA			X																
Illum. Impact-23 MOA	X																		
Illum. Impact-29 MOA	X																		
Impact-32 MOA					X														
Impact-60 MOA			X		X											X			
Tremor 2															X				
Illum. Tremor 2													X		X				
Tremor 3													X		X	X			
Illum. Tremor 3													X		X	X			
H59													X		X	X			
Illum. H59													X						
Illum. H27-D														X					
Mil Dot															X				
Illum. Mil Dot														X					
Tactical Milling Reticle (TMR)					X								X		X	X			
Illum. Tactical Milling Reticle (TMR)													X		X	X			
Illum. M-TMR														X					
Illum. TMR-D															X				
2.5-MOA DOT																			X
7.5-MOA Inscribed Delta																			X
Red Dot (1-MOA)																	X		

# AR-BALLISTIC

VX-FREEDOM

## FULL RETICLE

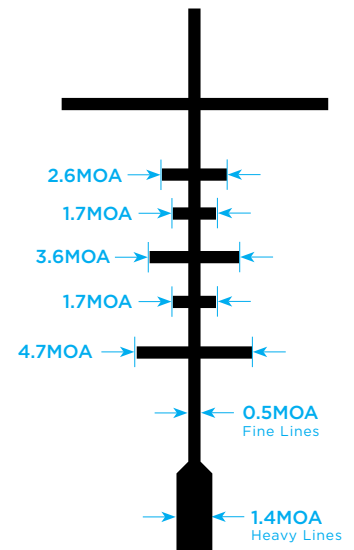
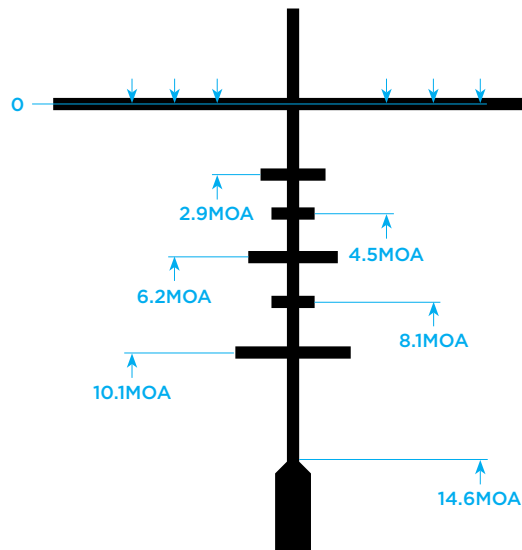
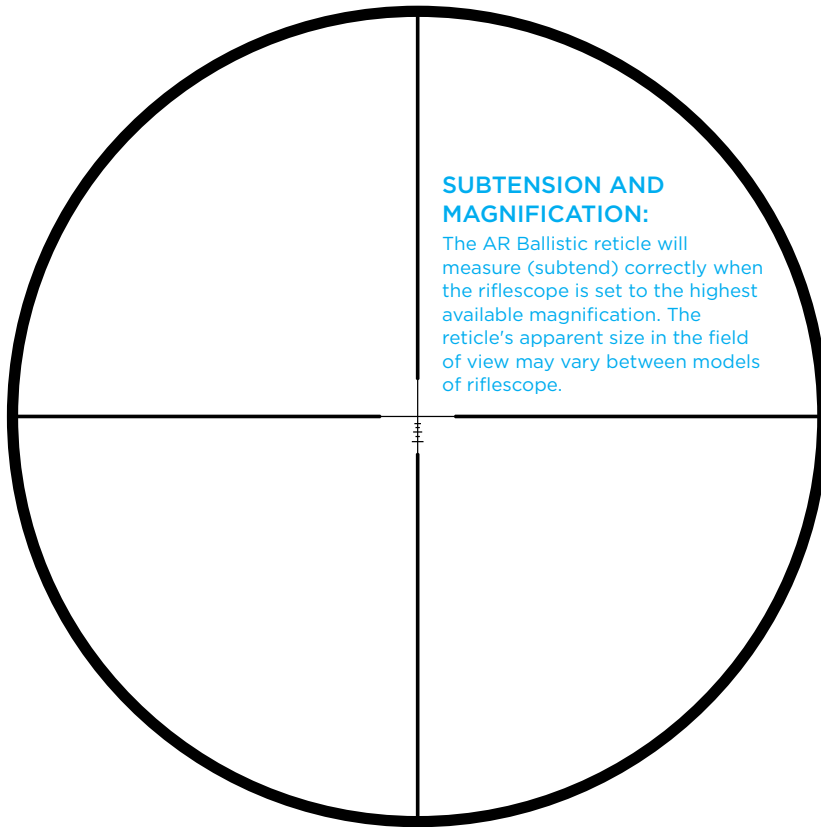

# BULL-RING POST RETICLE

## RETICLE FEATURES

- Bull-Ring circles standard NRA Service Rifle targets with an easy to center white ring
- The vertical post from the bottom provides a quick and accurate indicator of precise shot placement
- Bold pickets from the sides help visualize target centering and level cheekweld
- A simple line from the top reduces target obstruction

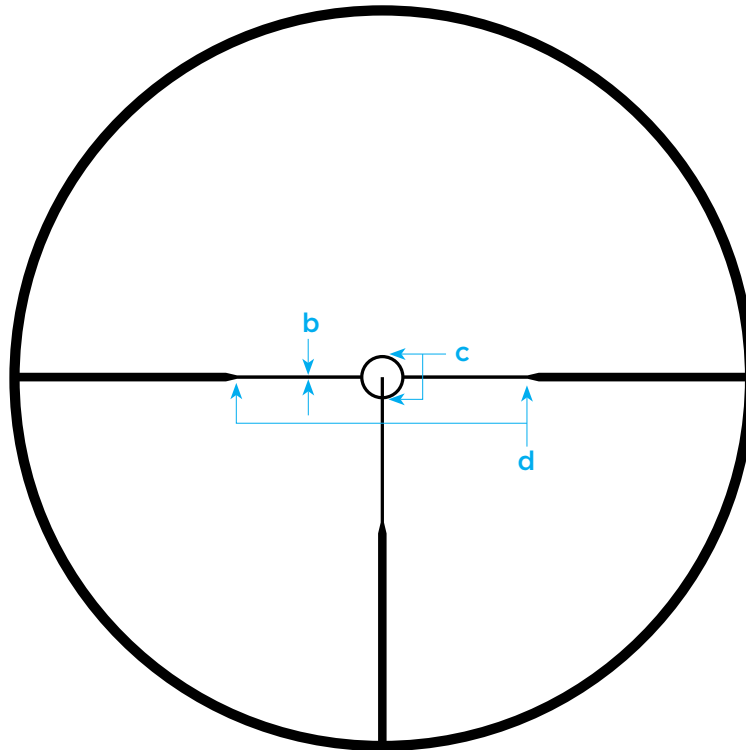

**BULL-RING POST,  
VX-4.5HD SERVICE  
RIFLE (MOA)**

	a = Heavy Line		b = Thin Line		c = Circle Diameter		d = Thin Opening	
	High-X	Low-X	High-X	Low-X	High-X	Low-X	High-X	Low-X
1-4.5x	1.7	8.2	0.7	3.2	7.7	36.4	60.0	280.3



# CMR-W

D-EVO

## FULL RETICLE

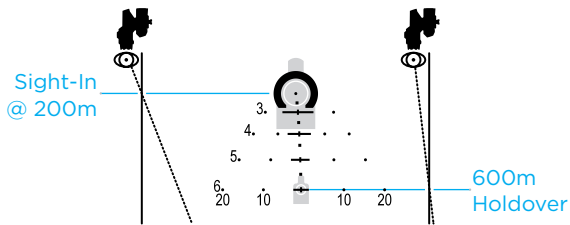
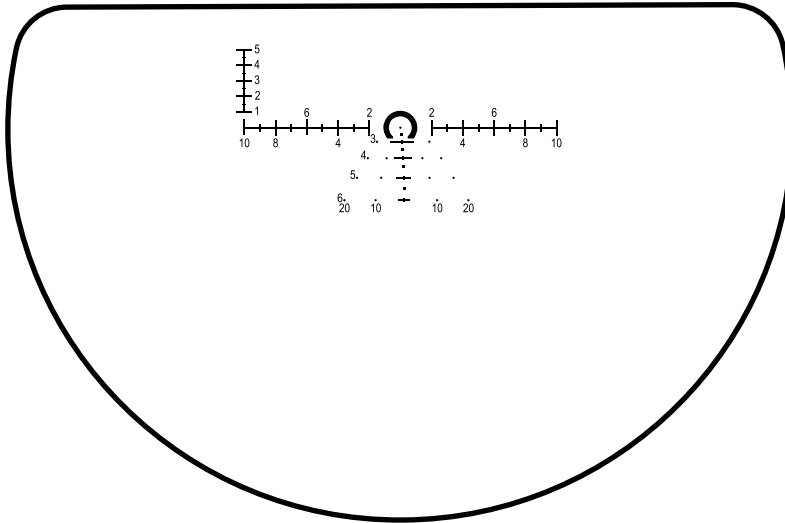

### CMR-W RANGE HOLDOVERS AND WIND HOLDS:

The shooter will notice that the vertical line of the reticle is curved. This is not a mistake, but a calculated adjustment to the reticle due to the fact that the D-EVO has an off-axis objective lens. This curved reticle line follows the trajectory of the bullet as viewed from this off-axis objective lens.

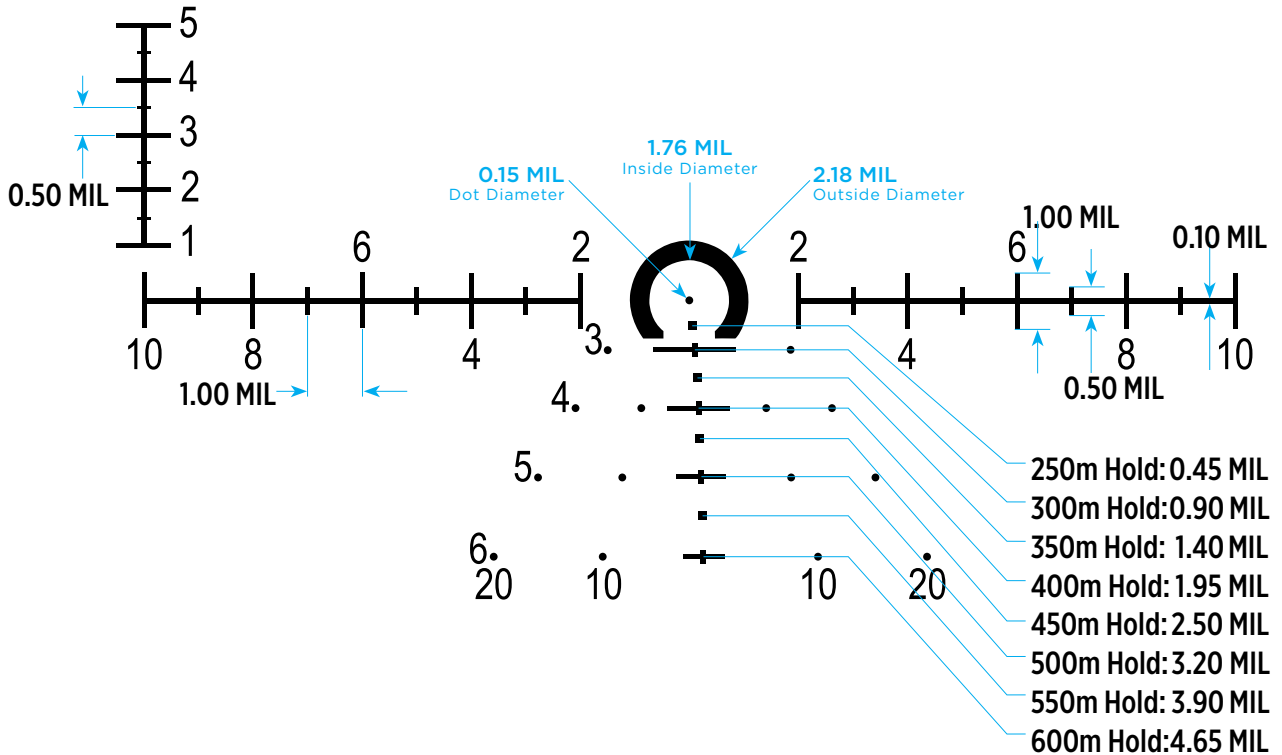

# FFP M-TMR ILLUMINATED

[TACTICAL MILLING RETICLE]

MARK 8

RETICLES

## FULL RETICLE

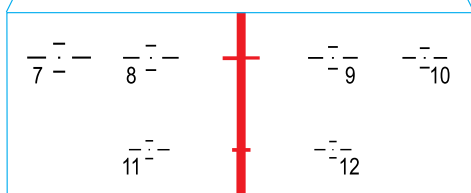
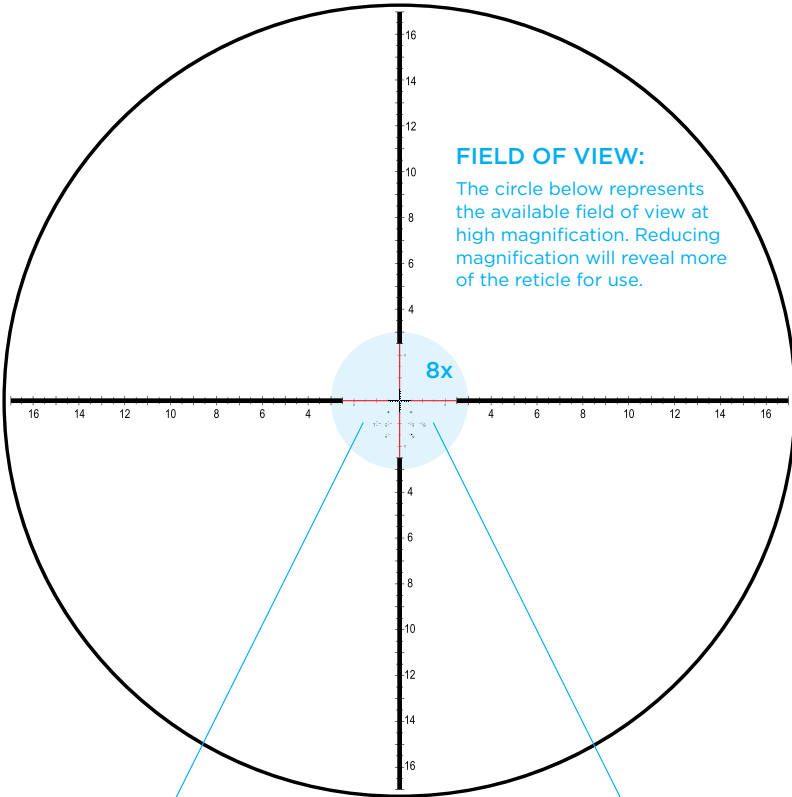

RAPID ACQUISITION RANGING BRACKETS RELAY DISTANCE TO TARGET IN 100S OF METERS

Measurements below work for each indicated range

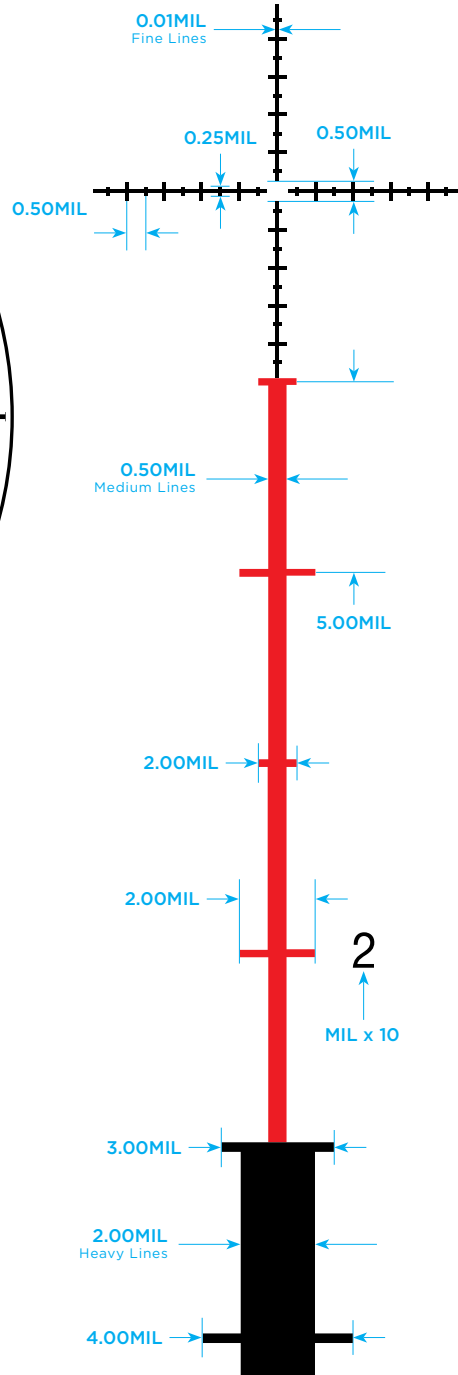
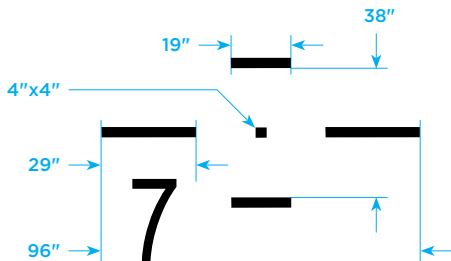

# FFP MIL DOT ILLUMINATED

(CQBSS)

MARK 8

FULL RETICLE

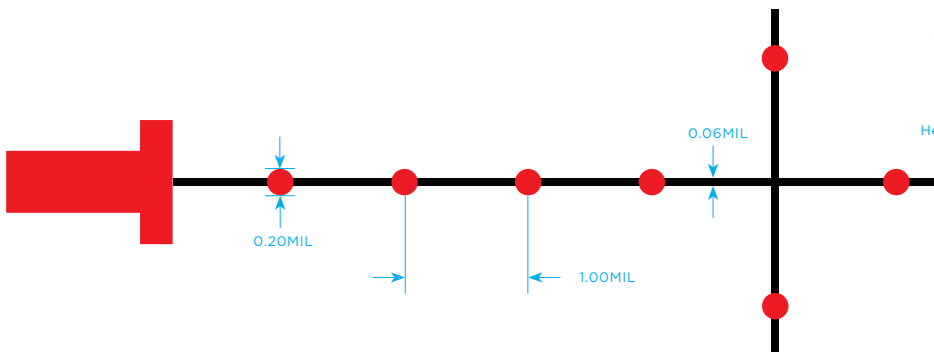
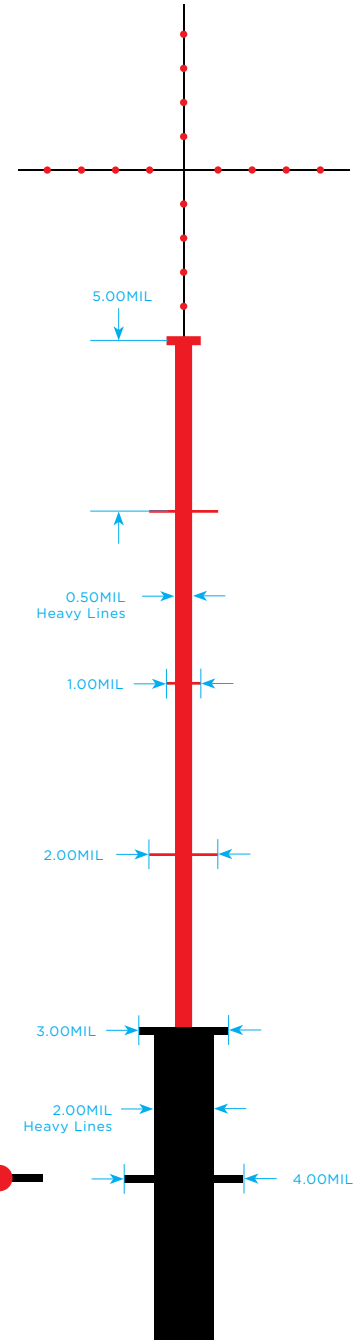
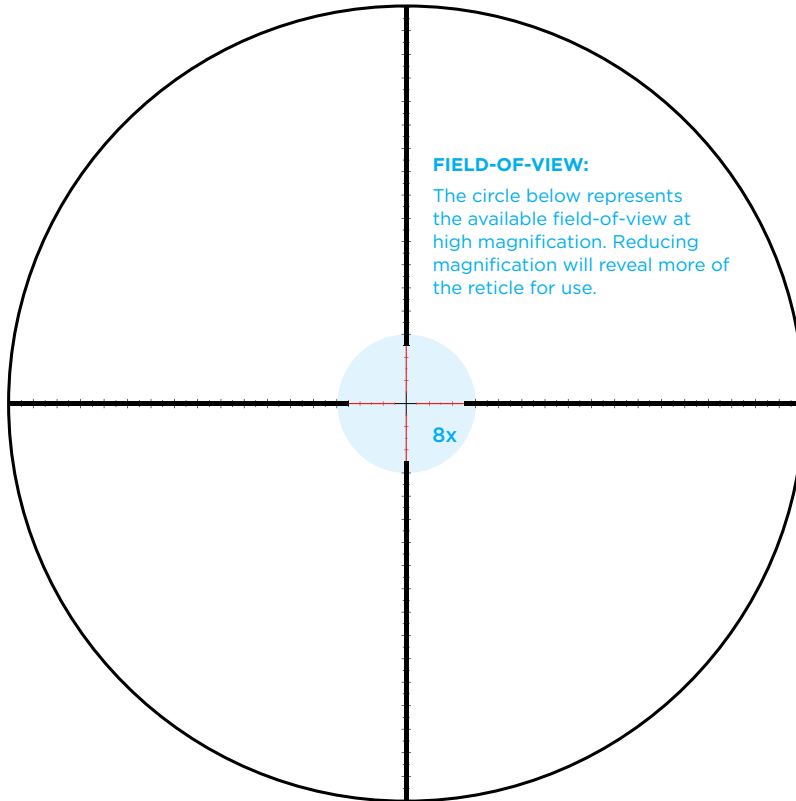

# FFP TMR-D ILLUMINATED

MARK 6

FULL RETICLE

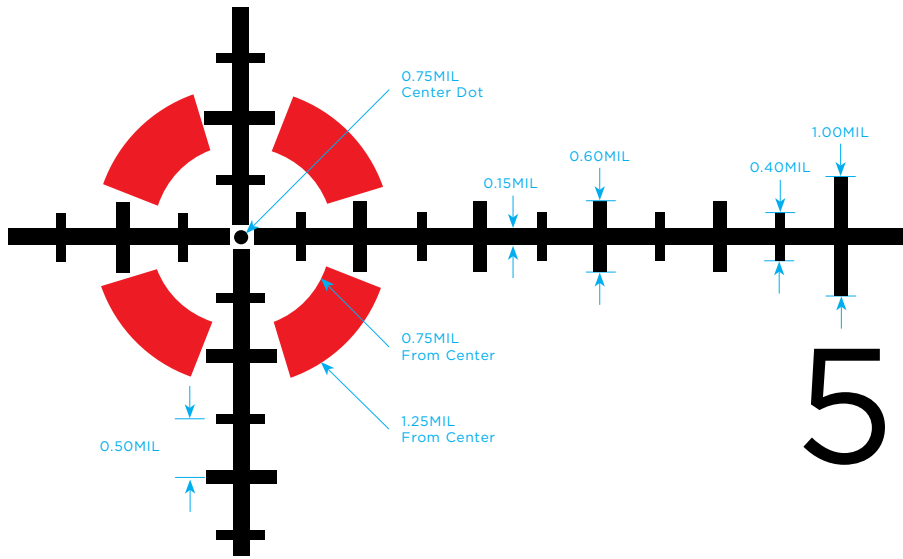
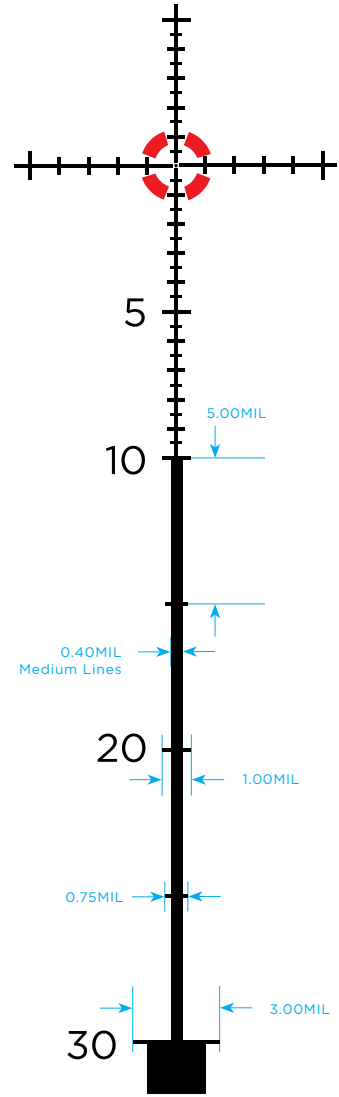
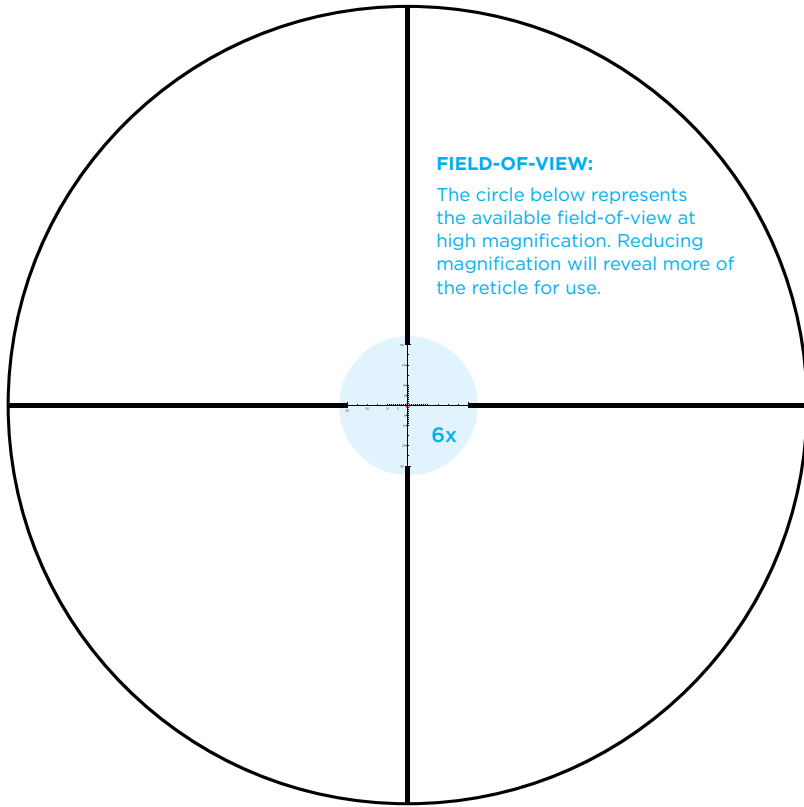

# FFP IMPACT

[SPOTTING SCOPE]

GOLD RING SPOTTING SCOPE

## FULL RETICLE

### FIELD-OF-VIEW:

The circle below represents the available field-of-view at high magnification. Reducing magnification will reveal more of the reticle for use.

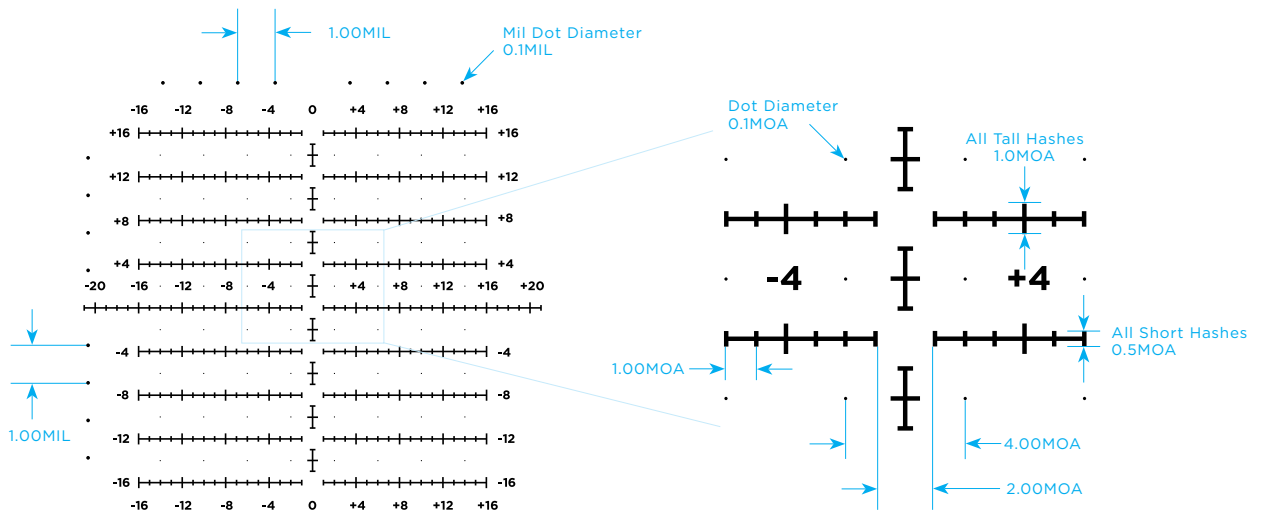
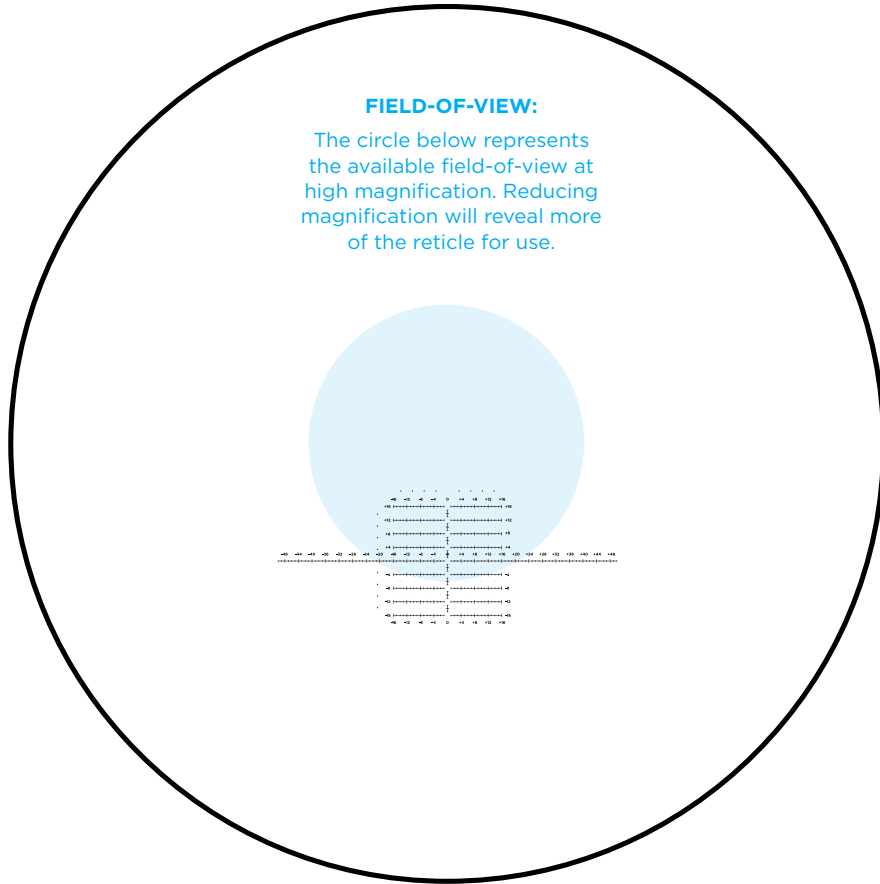

# FFP IMPACT-60 MOA

VX-3I LRP, MARK 5HD

RETICLES

FULL RETICLE

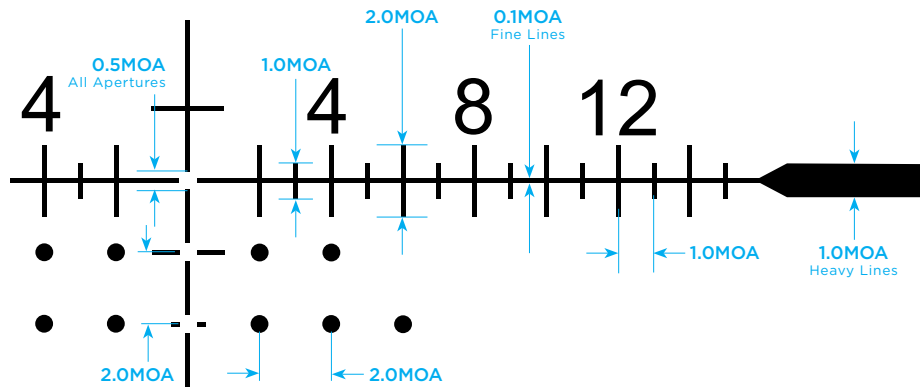
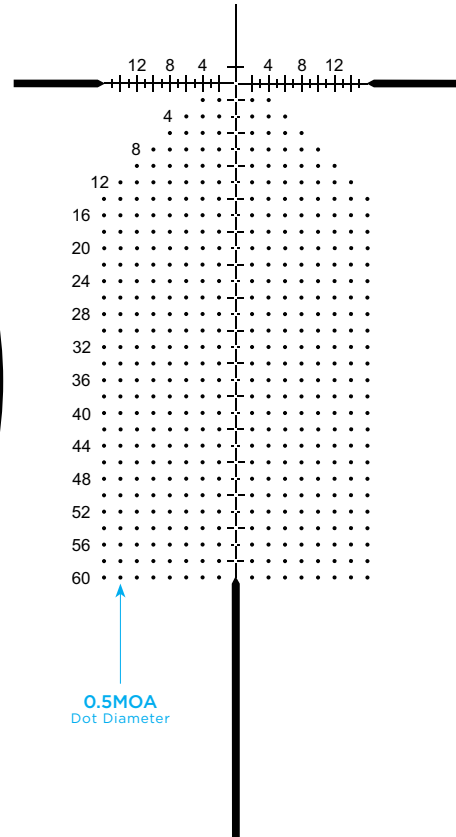
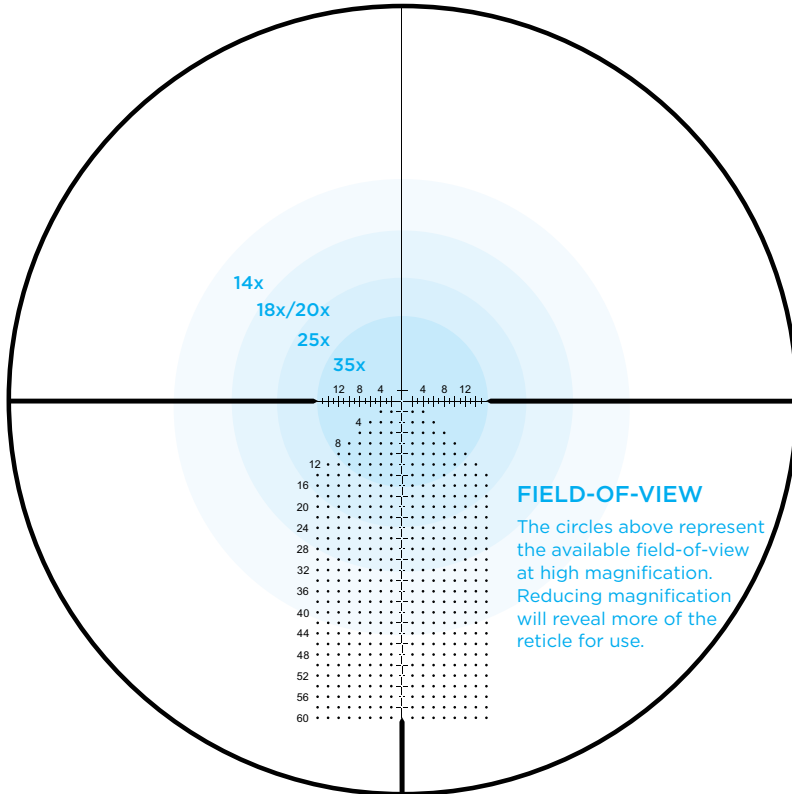

# FFP TMR

[TACTICAL MILLING RETICLE]

VX-3I LRP

FULL RETICLE

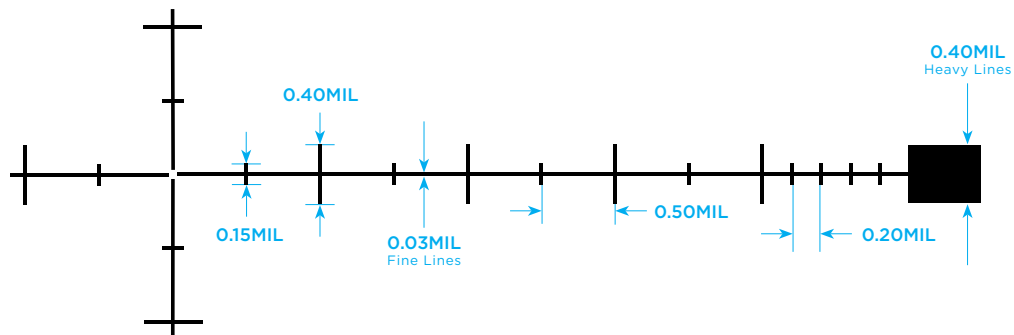
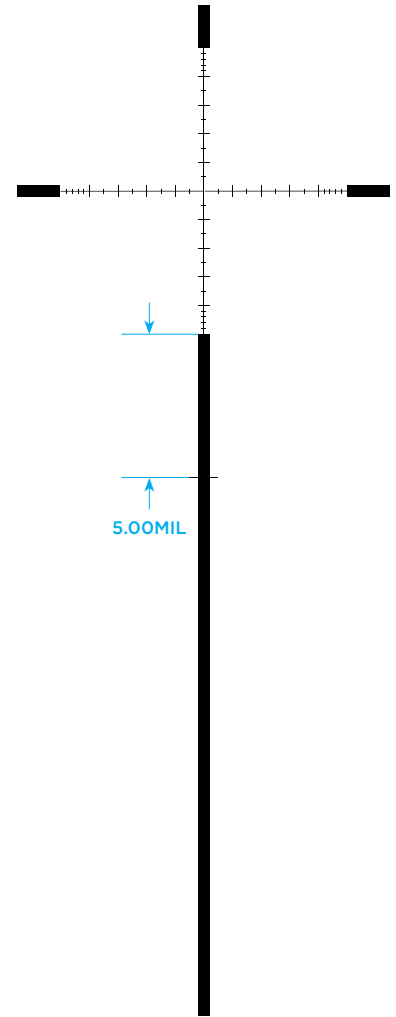
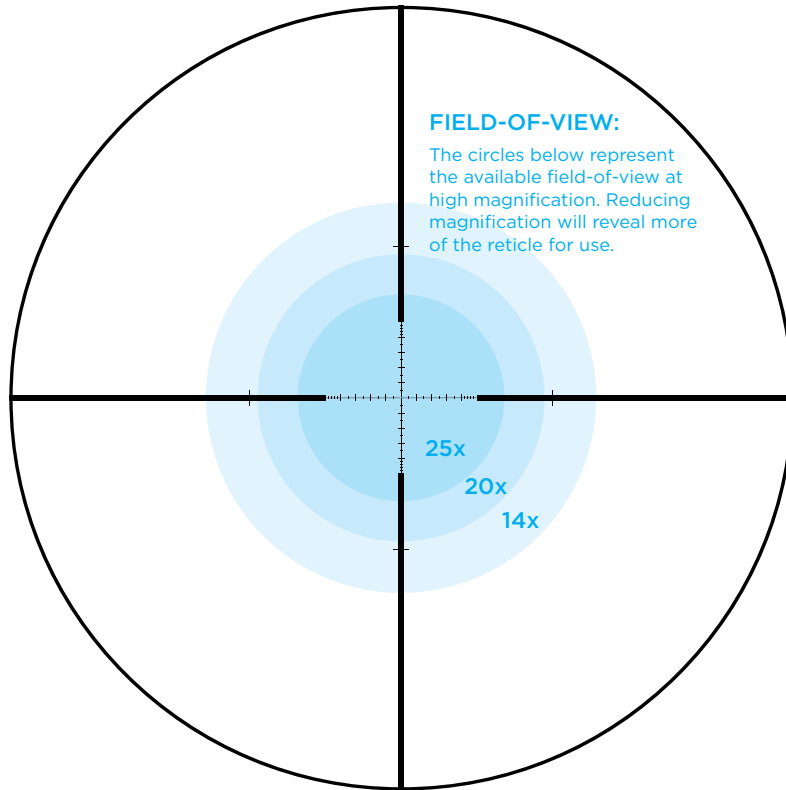

# FFP MIL DOT

MARK 6

FULL RETICLE

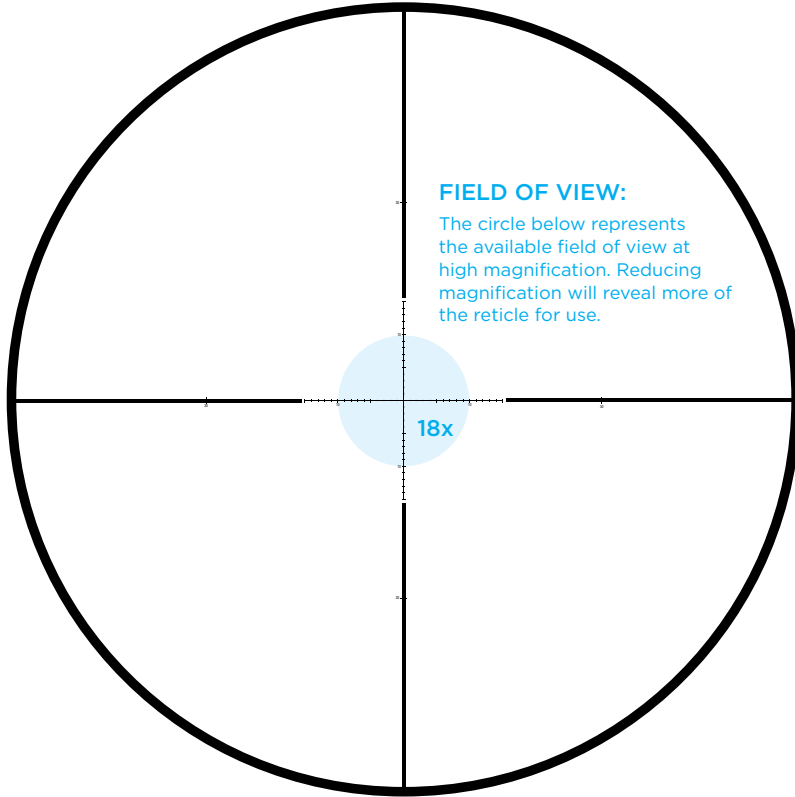

### FIELD OF VIEW:

The circle below represents the available field of view at high magnification. Reducing magnification will reveal more of the reticle for use.

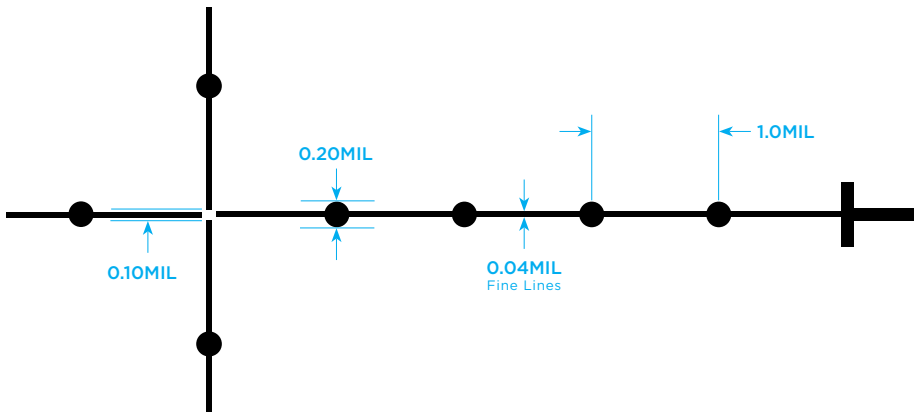
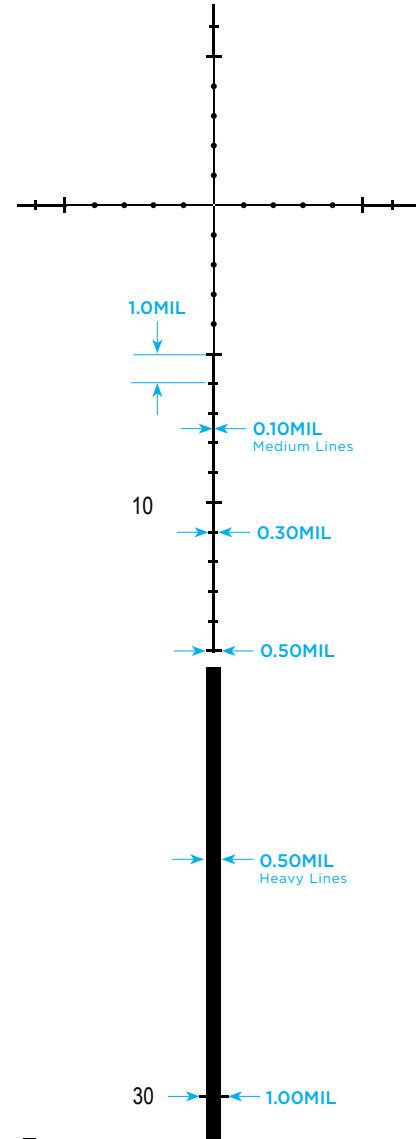



# FFP MIL DOT (SPOTTING SCOPE)

MARK 4 SPOTTING SCOPE

## FULL RETICLE

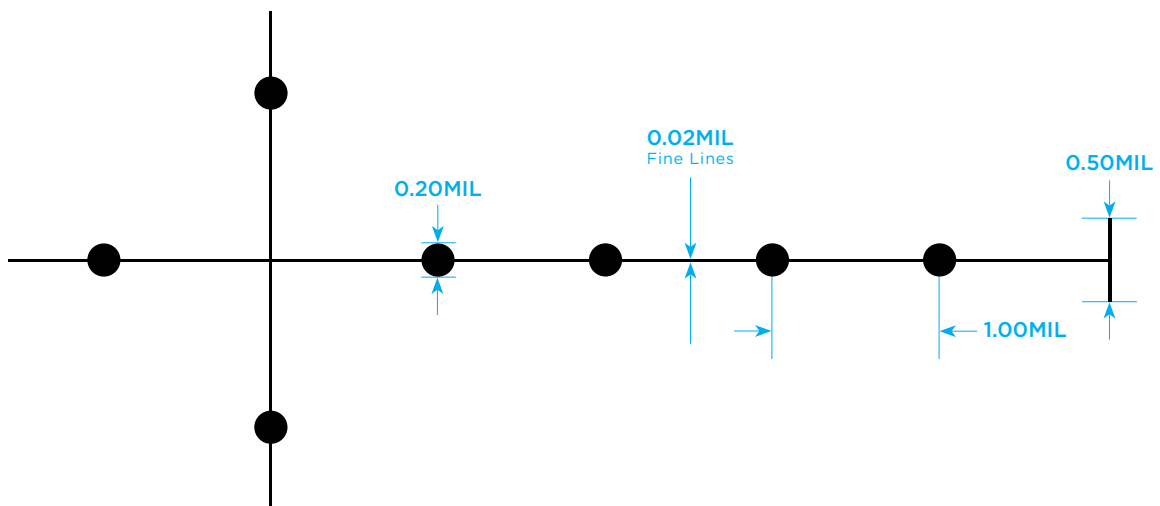
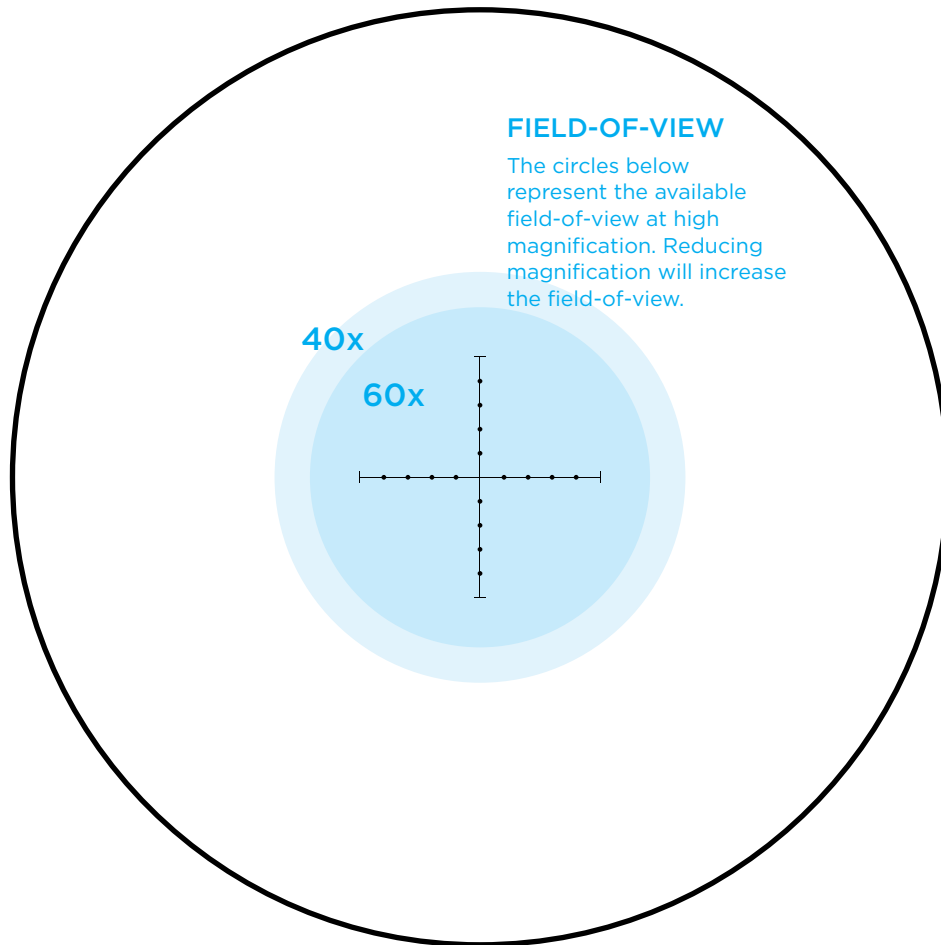

# FFP TMR

[TACTICAL MILLING RETICLE]

MARK 5HD, MARK 6, MARK 8

RETICLES

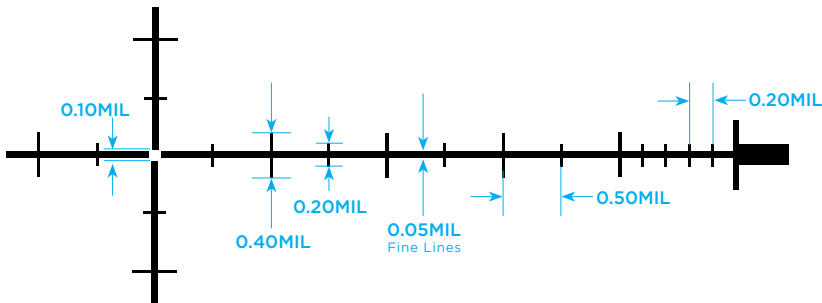
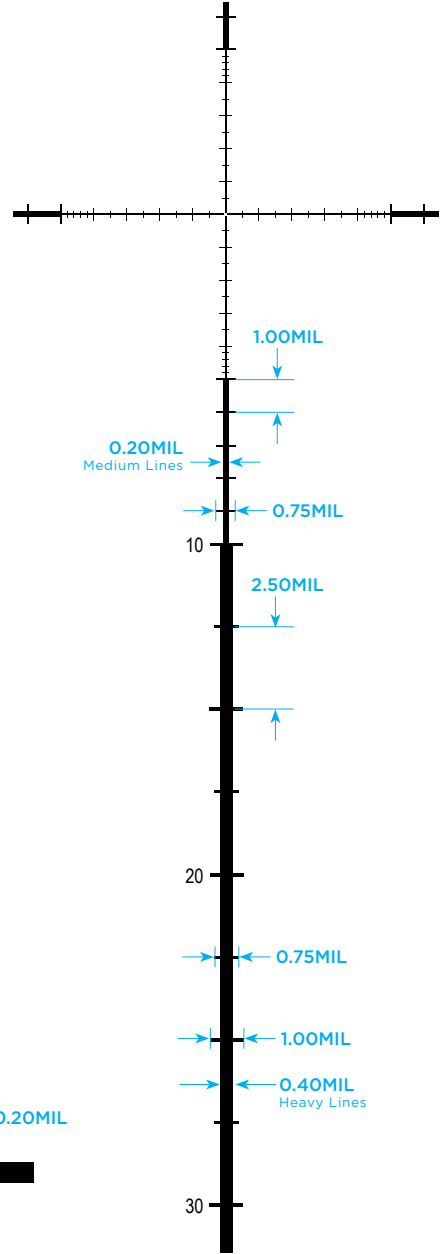
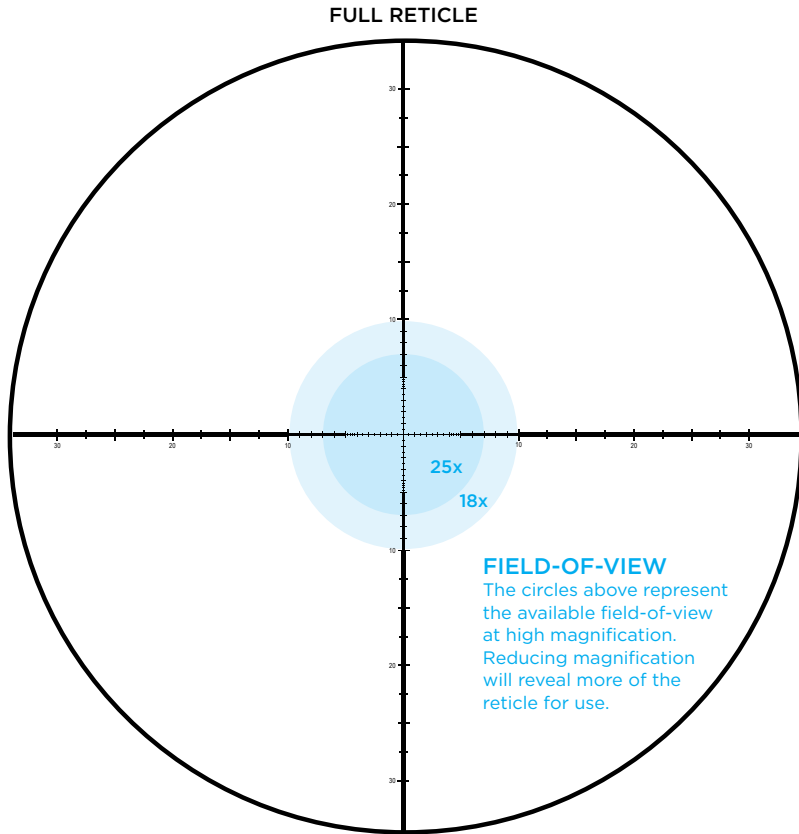

# FFP TMR ILLUMINATED

[TACTICAL MILLING RETICLE]

MARK 5HD, MARK 6, MARK 8

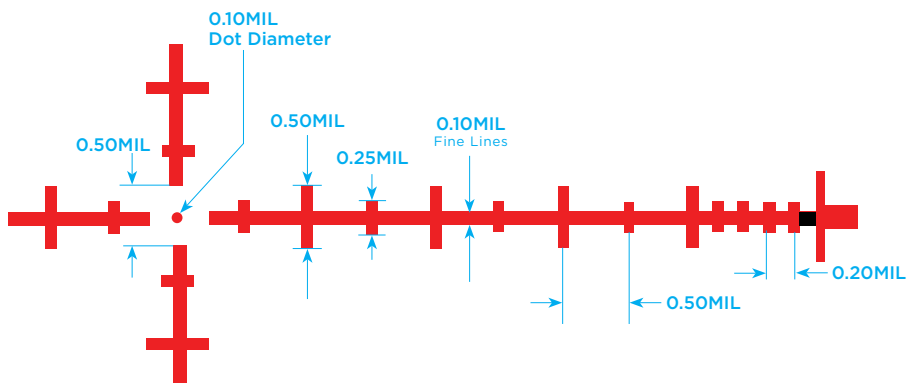
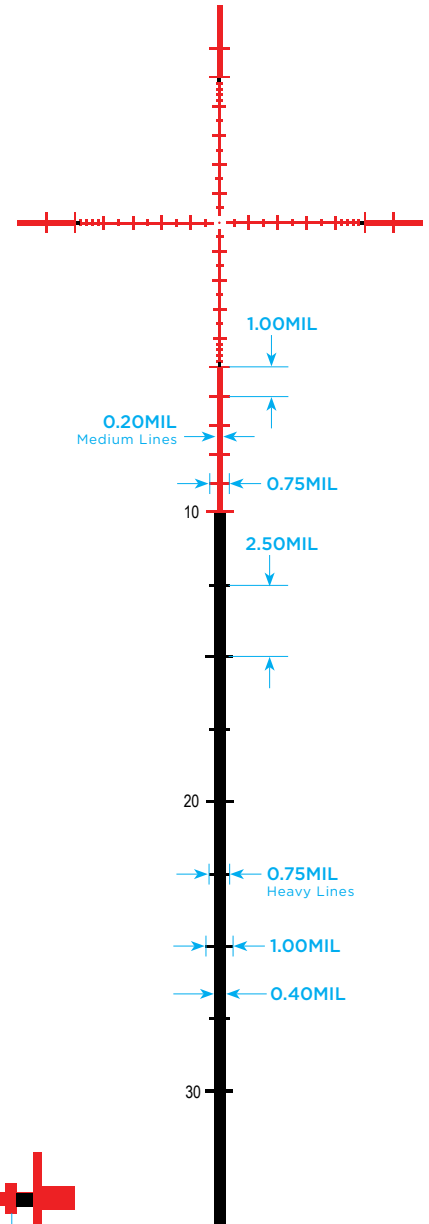
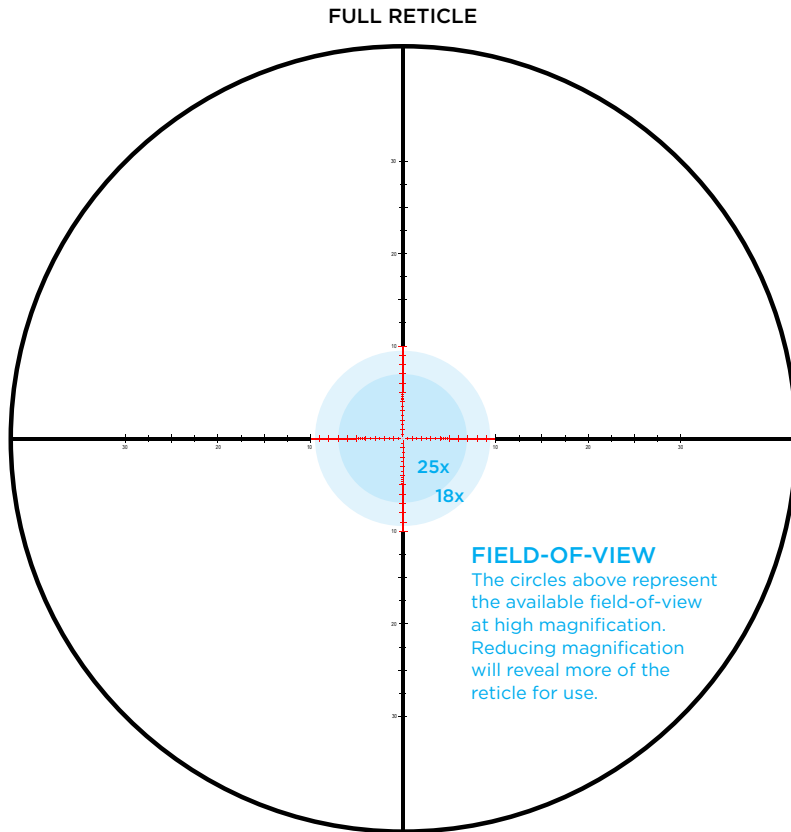

# FFP TMR (SPOTTING SCOPE)

[TACTICAL MILLING RETICLE]

MARK 4 SPOTTING SCOPE

## FULL RETICLE

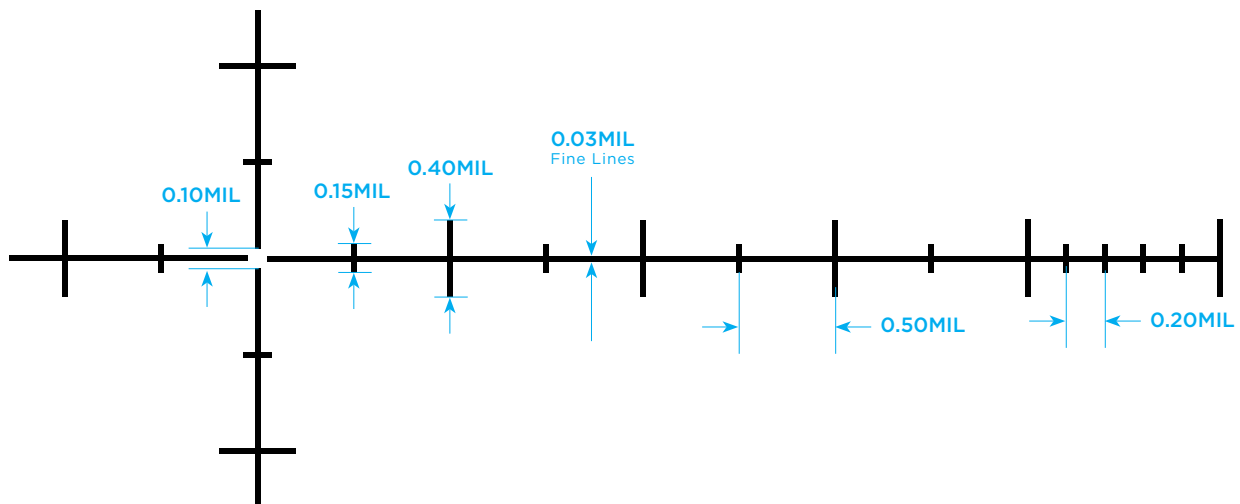
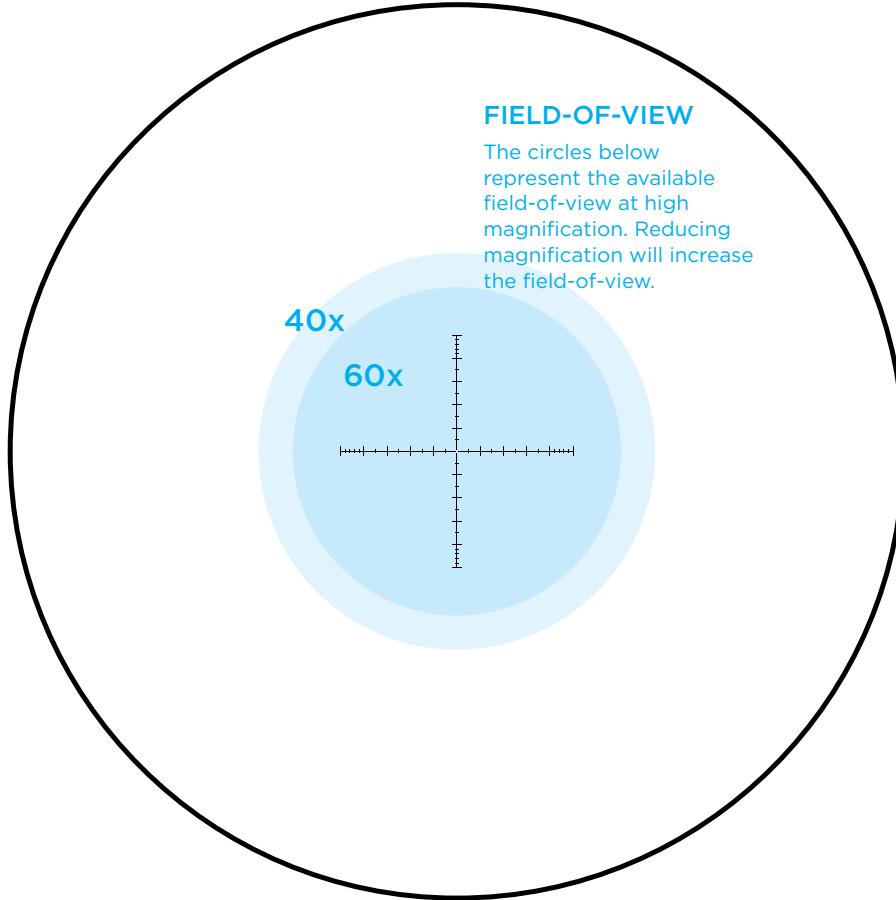

# FFP PR-1 MOA

MARK-5HD

FULL RETICLE

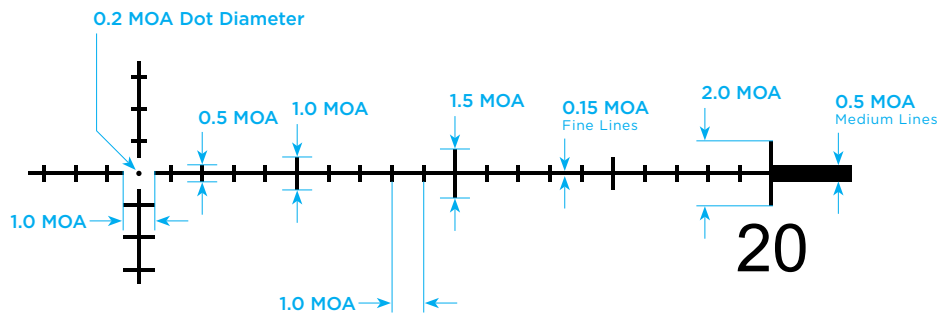
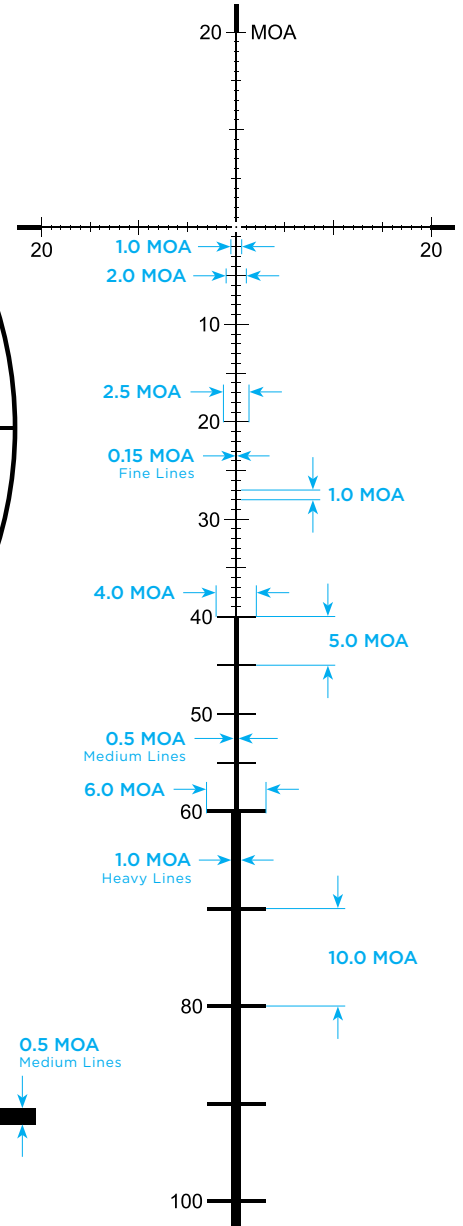
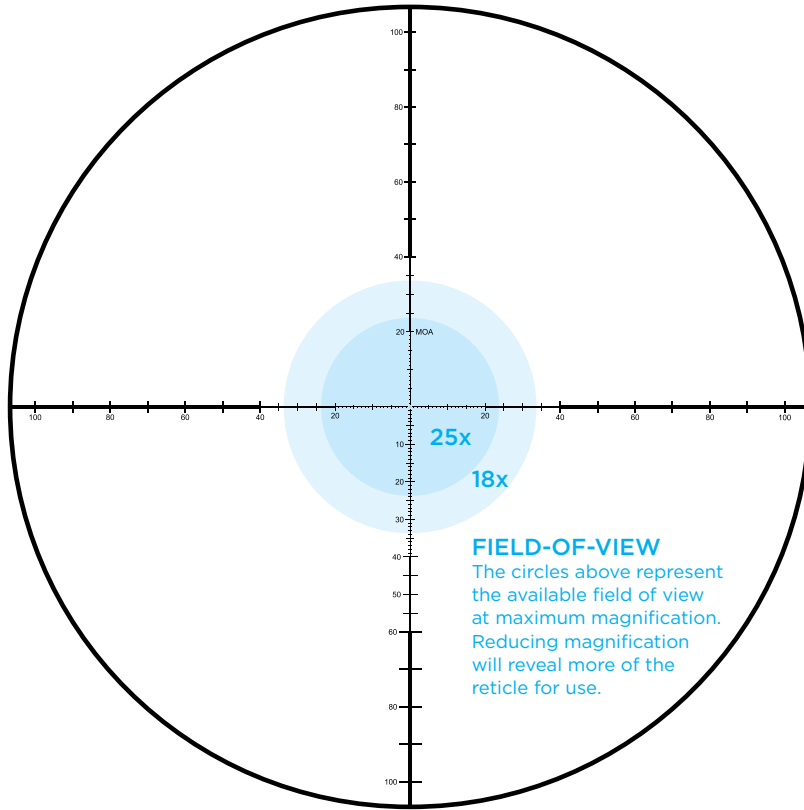

# FFP PR-1 MOA ILLUMINATED

MARK-5HD

RETICLES

FULL RETICLE

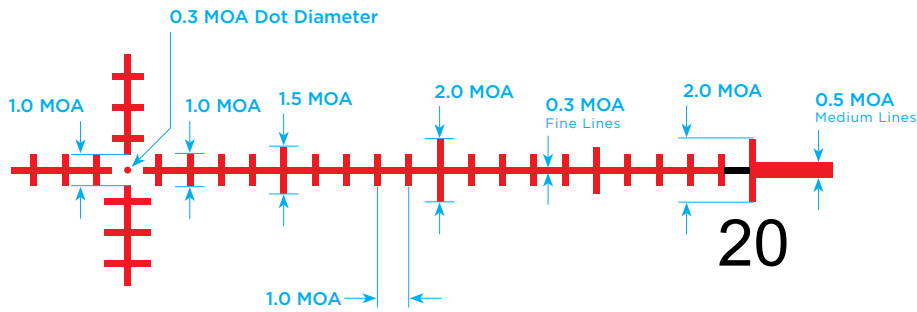
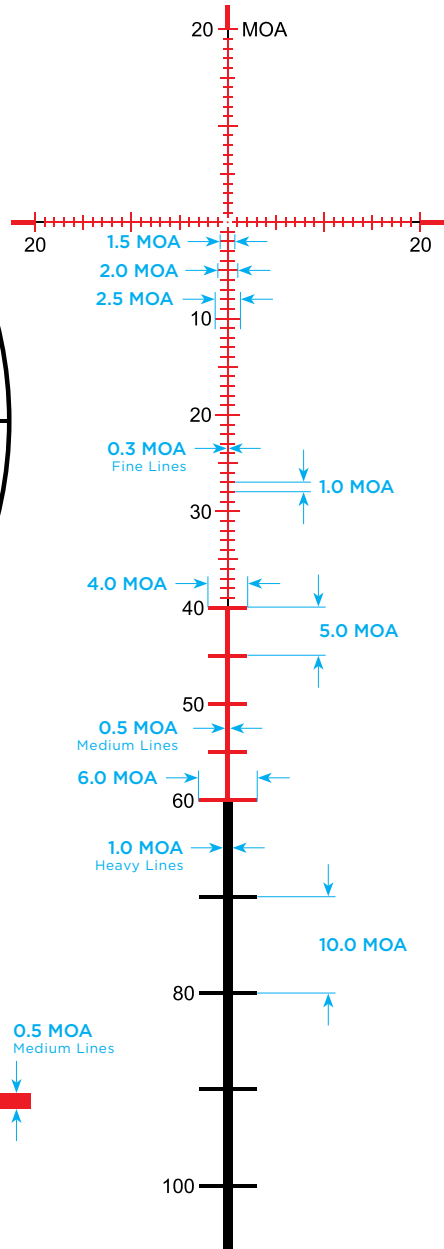
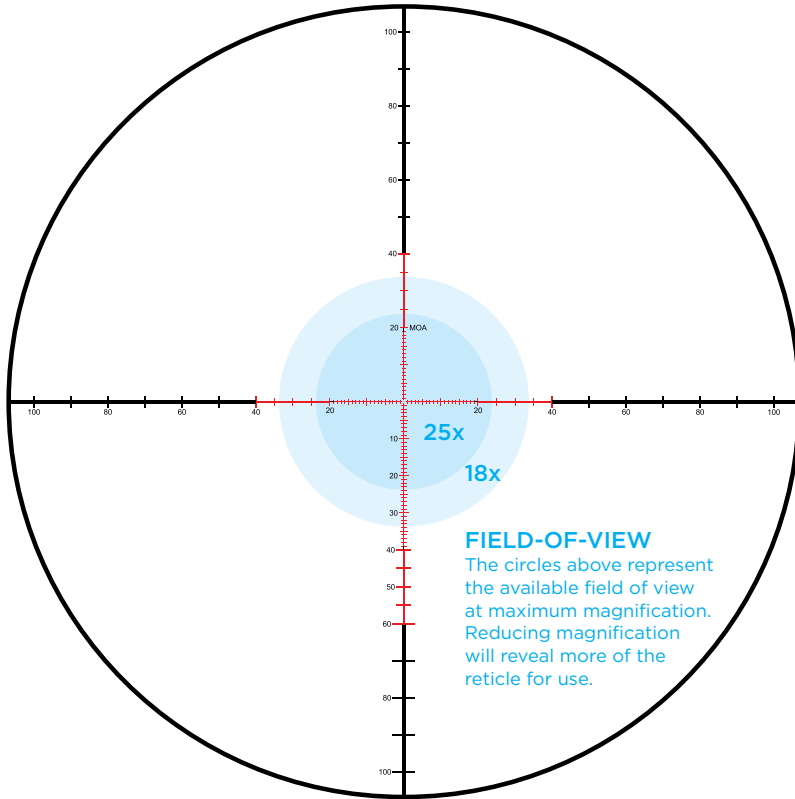

# FINE DUPLEX RETICLE

## RETICLE FEATURES

- Inspired by the Leupold-designed Duplex
- Thinner posts and crosshairs
- Better for precision shots
- Makes small target acquisition easier

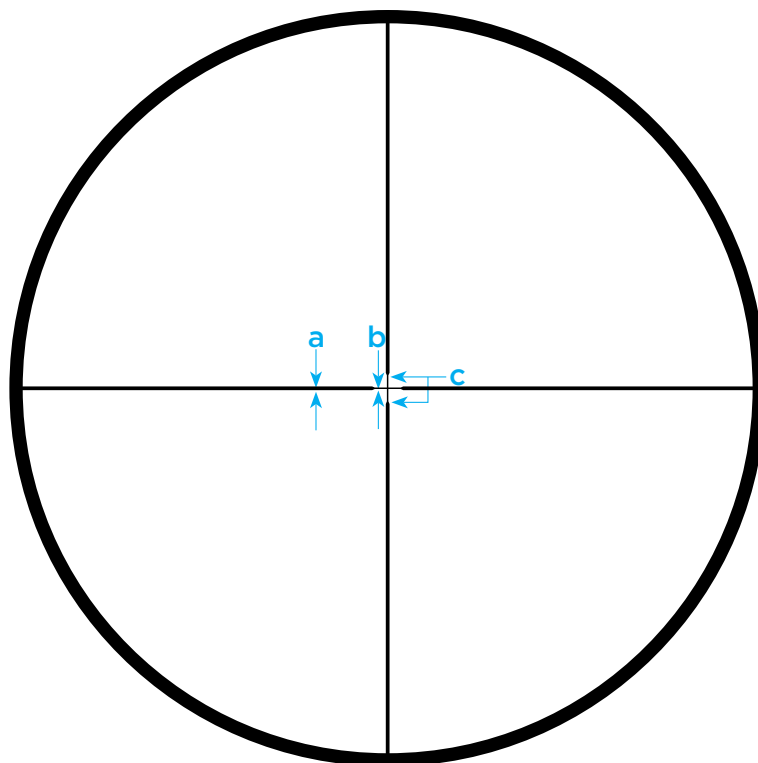

### FINE DUPLEX, VX-3i

	a = Heavy Line		b = Thin Line		c = Thin Opening	
	High-X	Low-X	High-X	Low-X	High-X	Low-X
6.5-20x	0.2	—	0.1	—	2.7	—
8.5-25x	0.2	—	0.1	—	2.1	—

### FINE DUPLEX, FX-1

	a = Heavy Line		b = Thin Line		c = Thin Opening	
	High-X	Low-X	High-X	Low-X	High-X	Low-X
4x	1.3	—	0.4	—	16.5	—

# ILLUM. FIREDOT MIL-RING

VX-FREEDOM

RETICLES

FULL RETICLE

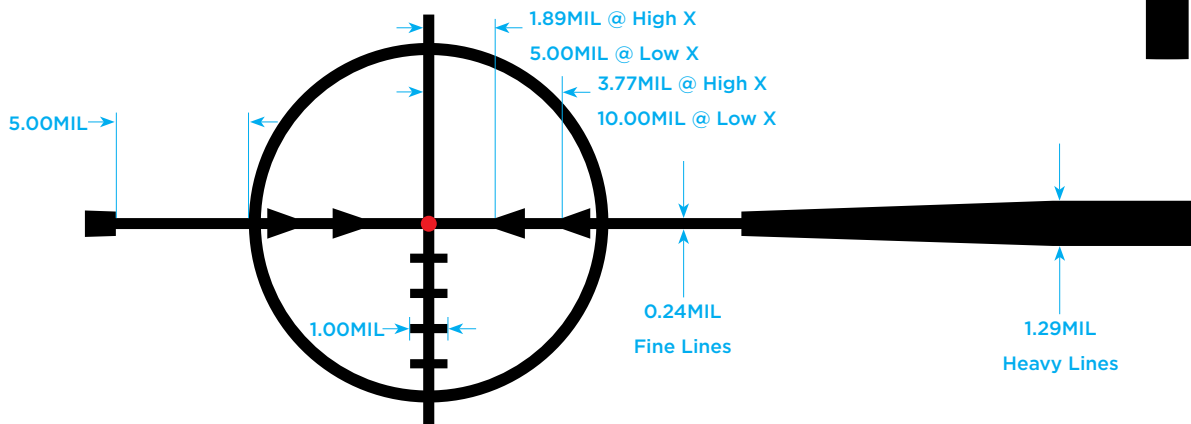
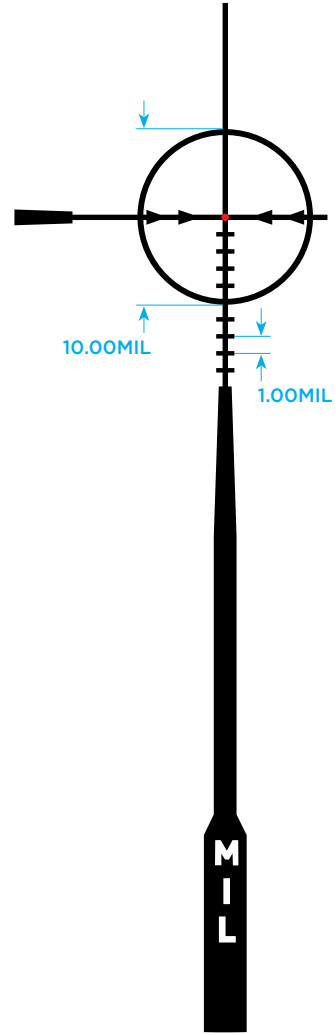
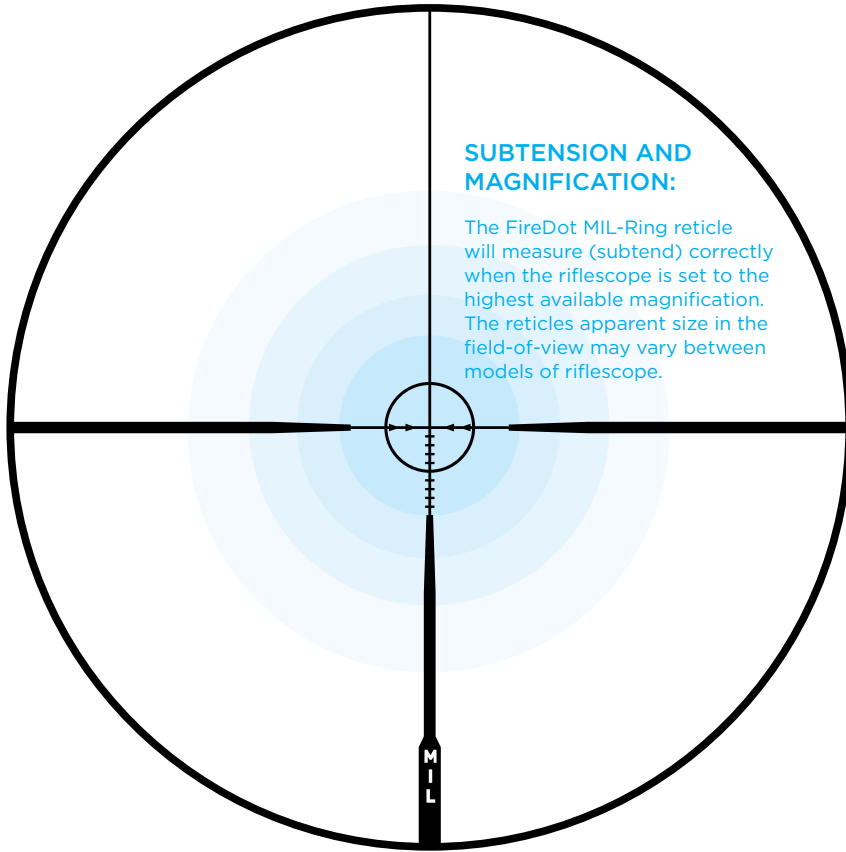



# ILLUMINATED FIREDOT MOA-RING

VX-FREEDOM

FULL RETICLE

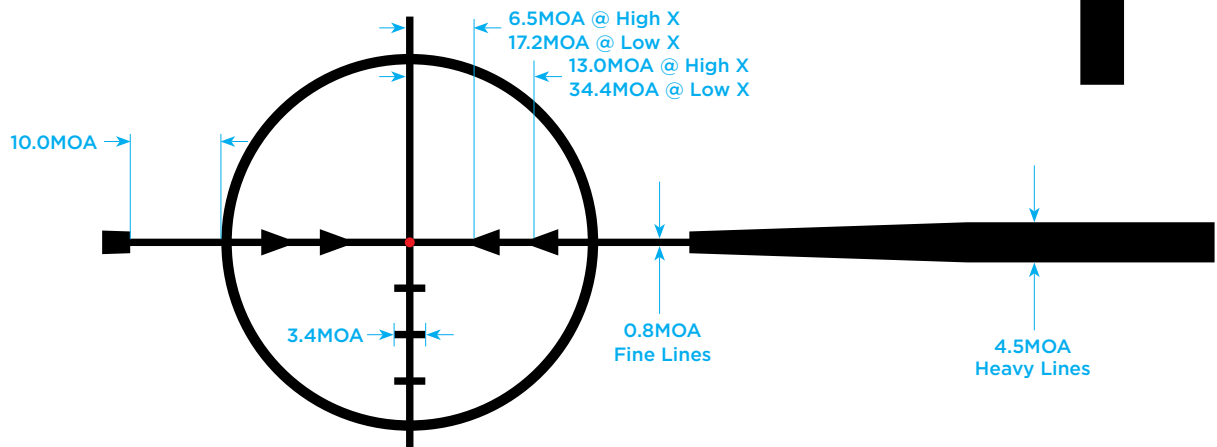
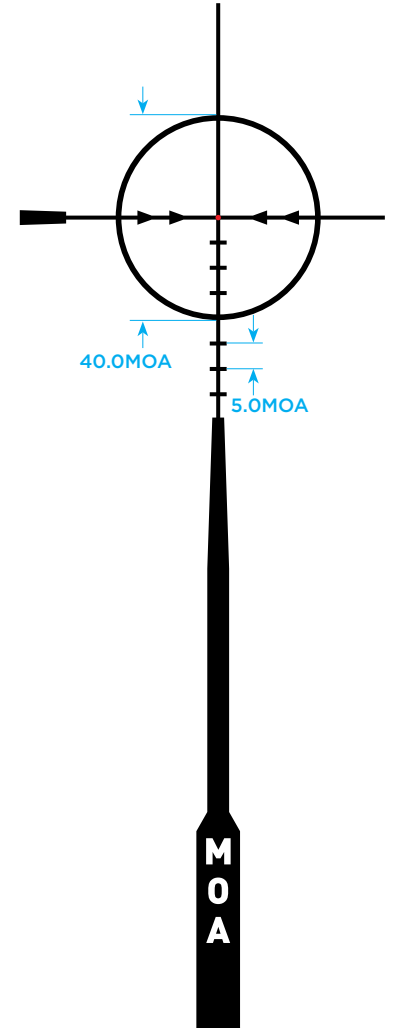
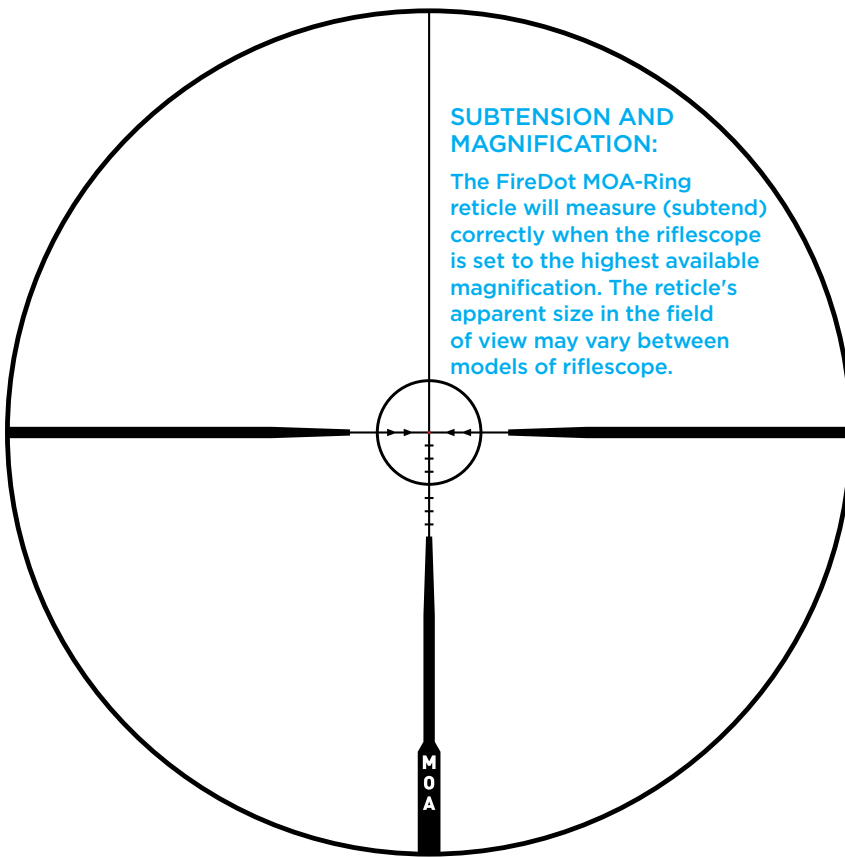

# FIREDOT TMR ILLUMINATED

[TACTICAL MILLING RETICLE]

VX-R PATROL

FULL RETICLE

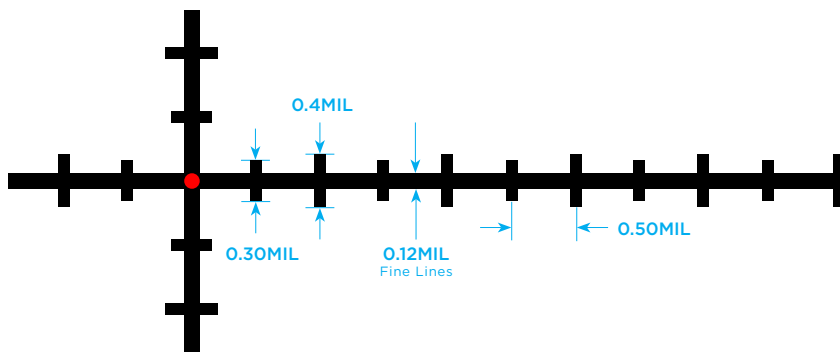
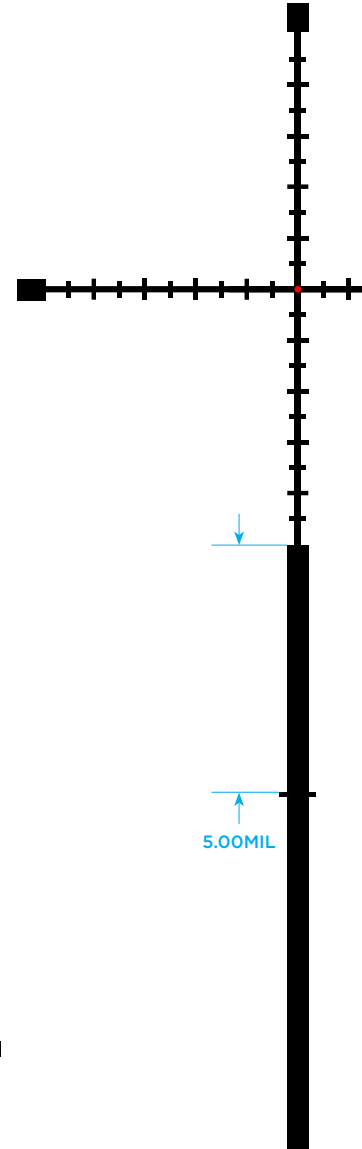
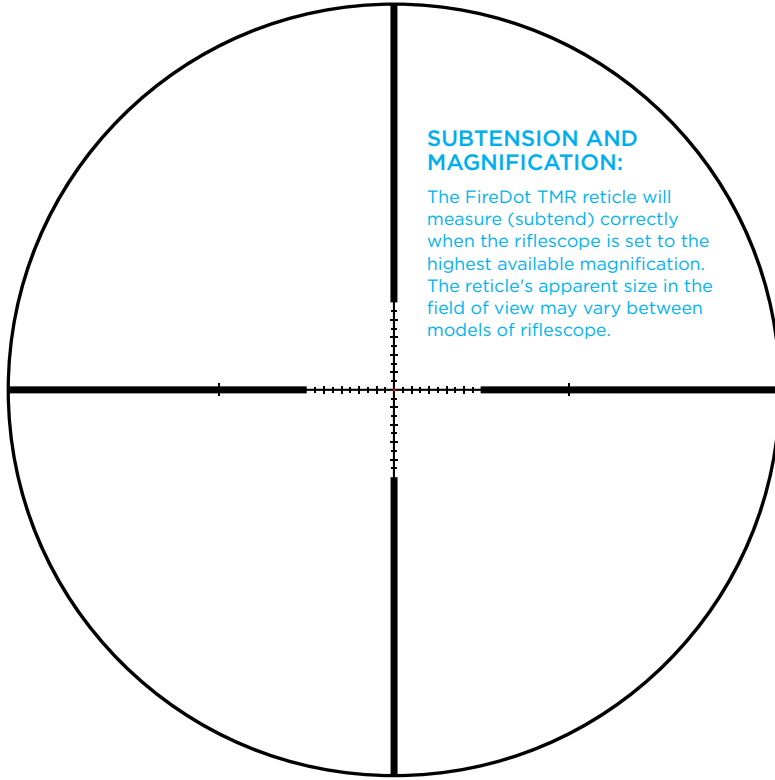

# ILLUMINATED FIREDOT TWILIGHT HUNTER

VX-FREEDOM

FULL RETICLE

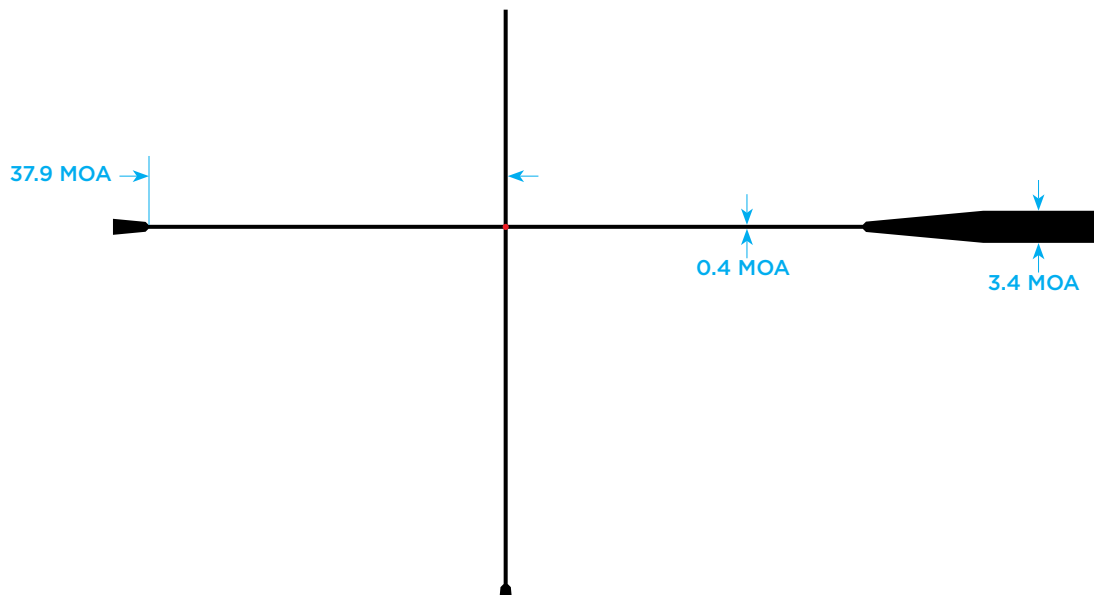
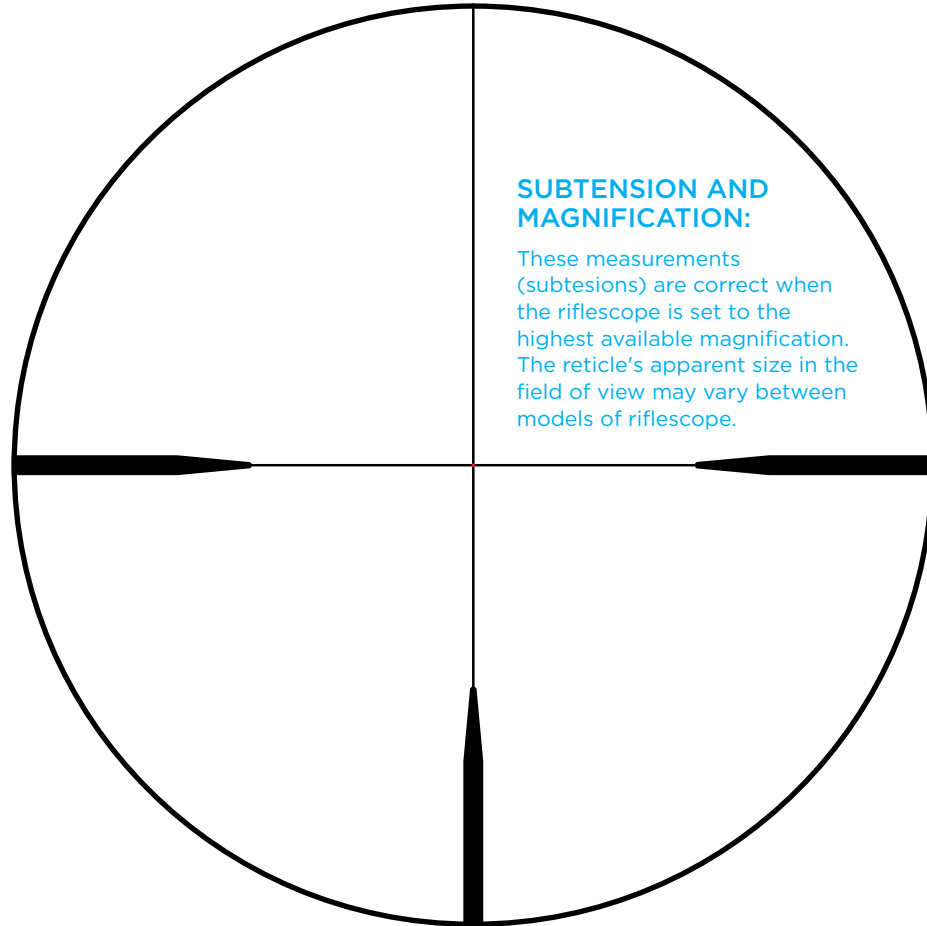

# FIREDOT 4 FINE RETICLE

## RETICLE FEATURES

- European influenced design
- Thinner outer posts for less target coverage
- Upper field of view kept free of obstructions
- Fiber-optic powered center red-dot
- Multiple brightness settings for changing conditions
- FireDot Technology brings your eye to the center of the reticle for quick target acquisition
- Features Leupold's own Motion Sensor Technology (MST)

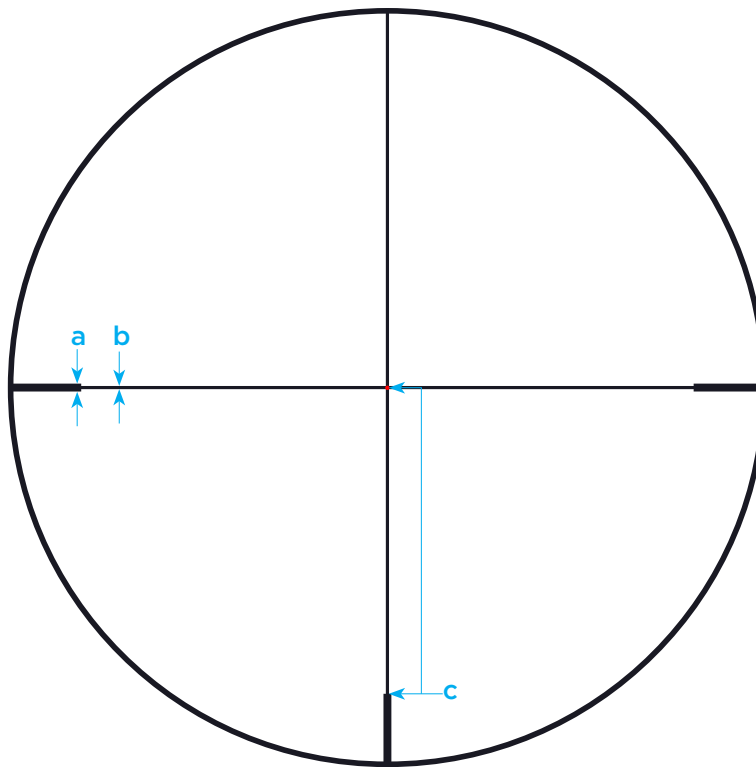

FIREDOT 4 FINE  
VX-6HD (MOA)

	a = Heavy Line		b = Thin Line		c = Center to Post	
	High-X	Low-X	High-X	Low-X	High-X	Low-X
1-6x	1.4	8.4	0.5	3.0	52.2	313.2

FIREDOT 4 FINE,  
VX-5HD (MOA)

	a = Heavy Line		b = Thin Line		c = Center to Post	
	High-X	Low-X	High-X	Low-X	High-X	Low-X
1-5x	1.7	8.5	0.7	3.5	64.0	320.0
3-15x	0.6	3.0	0.2	1.0	21.4	107.0

# FIREDOT BULL-RING RETICLE

## RETICLE FEATURES

- Bull-Ring circles standard NRA Service Rifle targets with an easy to center white ring
- Fiber-optic powered center red-dot
- Multiple brightness settings for changing conditions
- FireDot Technology brings your eye to the center of the reticle for quick target acquisition
- Features Leupold's own Motion Sensor Technology (MST)

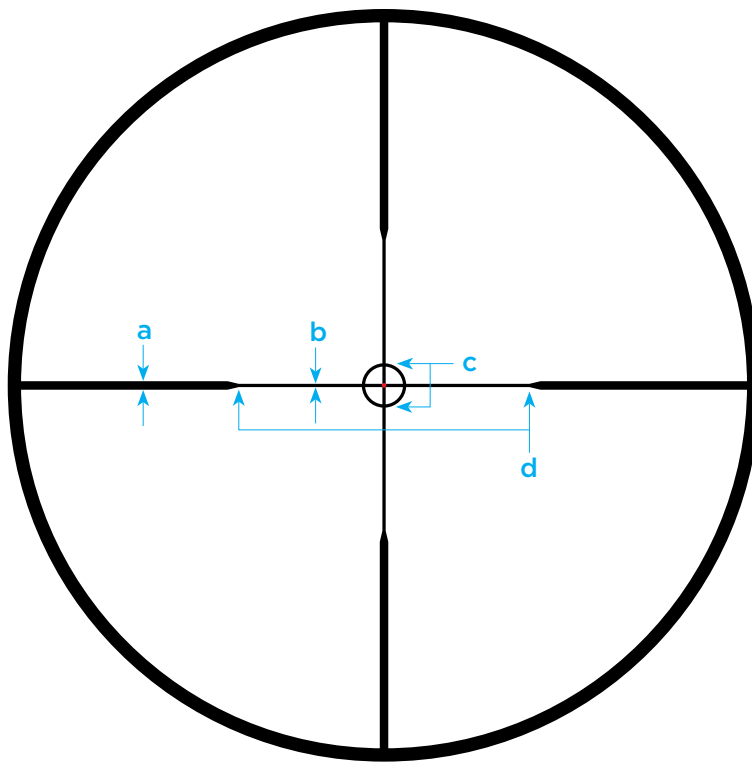

FIREDOT BULL-RING,  
VX-4.5 SERVICE RIFLE  
(MOA)

	a = Heavy Line		b = Thin Line		c = Circle Diameter		d = Thin Opening	
	High-X	Low-X	High-X	Low-X	High-X	Low-X	High-X	Low-X
1-4.5x	1.7	8.2	0.7	3.2	7.7	36.4	60.0	280.3

# FIREDOT DUPLEX RETICLE

## RETICLE FEATURES

- Brings new technology to a classic design
- Fiber-optic powered center red-dot
- Multiple brightness settings for changing conditions
- FireDot Technology brings your eye to the center of the reticle for quick target acquisition
- Broad range of shooting applications

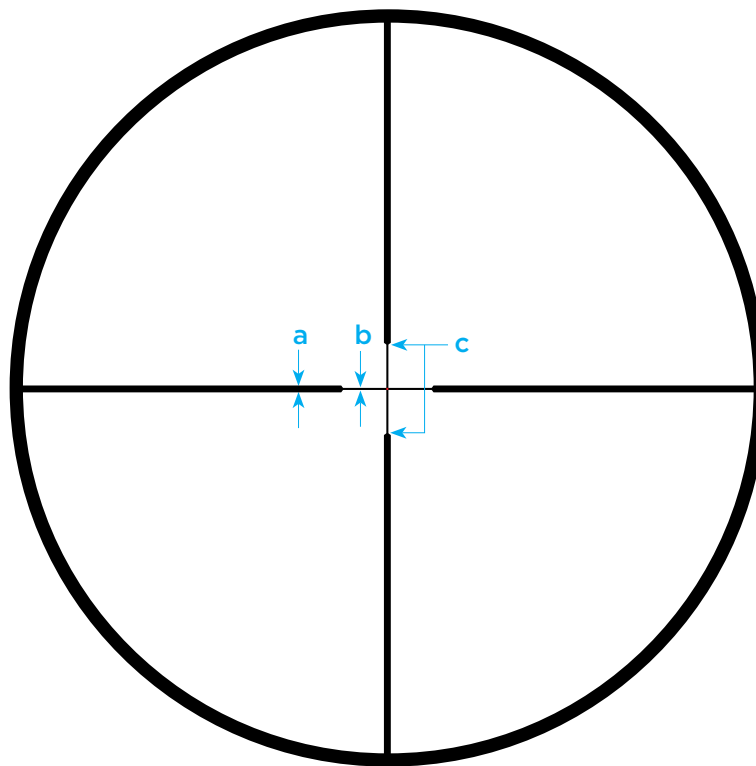

**FIREDOT DUPLEX,  
VX-6HD**

	a = Heavy Line		b = Thin Line		c = Thin Opening	
	High-X	Low-X	High-X	Low-X	High-X	Low-X
1-6x	2.7	16.2	0.5	3.0	28.8	175.8
2-12x	1.4	8.4	0.3	1.8	15.3	91.8
3-18x	0.5	3.0	0.2	1.2	15.3	91.8

**FIREDOT DUPLEX,  
VX-5HD**

	a = Heavy Line		b = Thin Line		c = Thin Opening	
	High-X	Low-X	High-X	Low-X	High-X	Low-X
1-5x	1.7	8.5	0.7	3.5	56.3	281.5
2-10x	0.8	4.0	0.3	1.5	28.6	143.0
3-15x	0.6	3.0	0.2	1.0	18.8	94.0

# HPR-1

FX-4.5HD

## FULL RETICLE

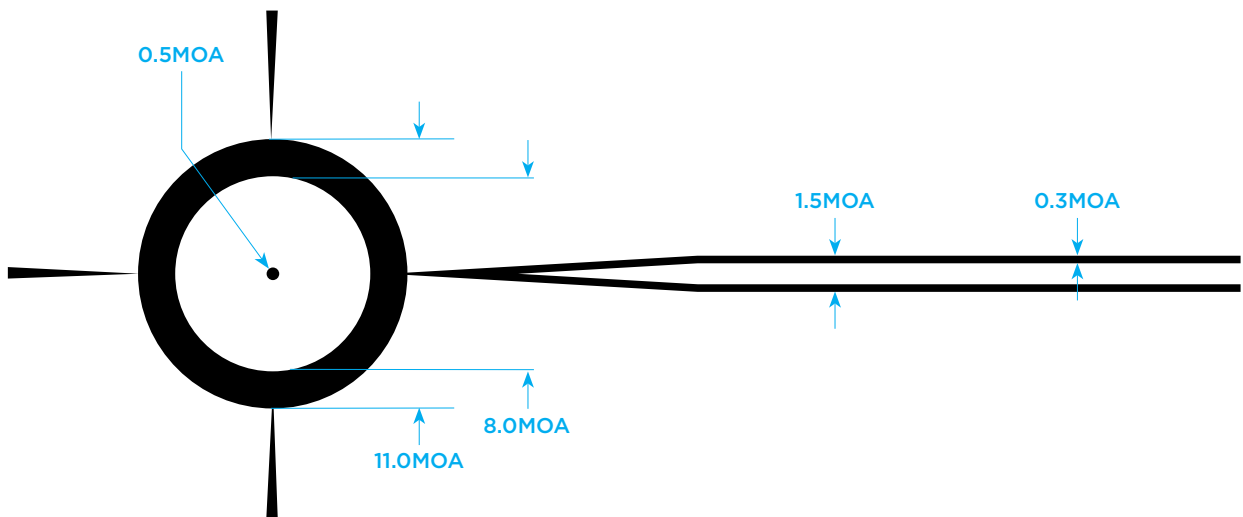
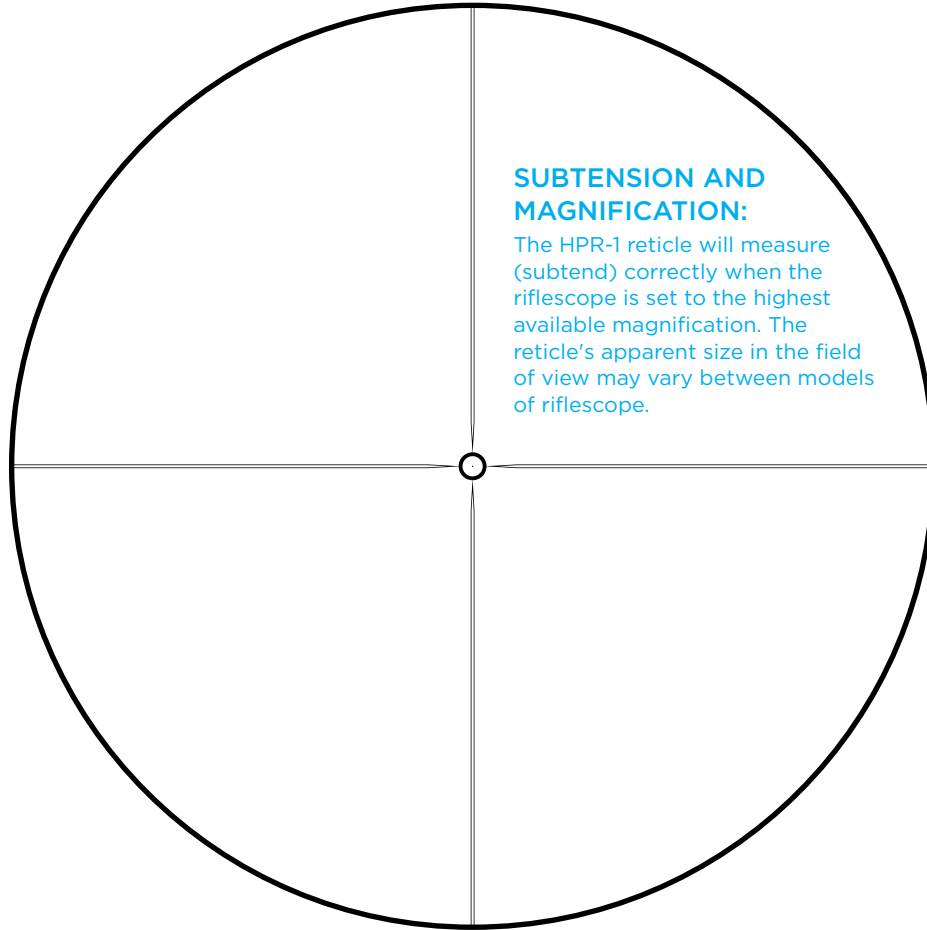

# ILLUM. FIREDOT TRI-MIL

VX-FREEDOM

RETICLES

FULL RETICLE

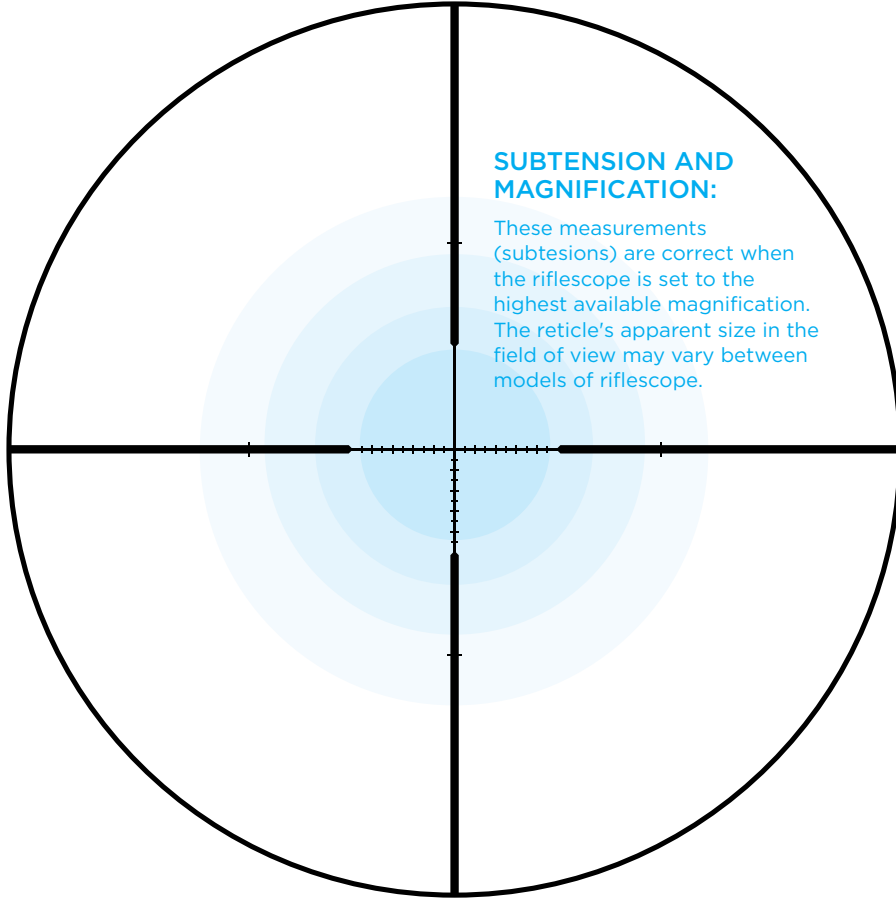

## SUBTENSION AND MAGNIFICATION:

These measurements (subtensions) are correct when the riflescope is set to the highest available magnification. The reticle's apparent size in the field of view may vary between models of riflescope.

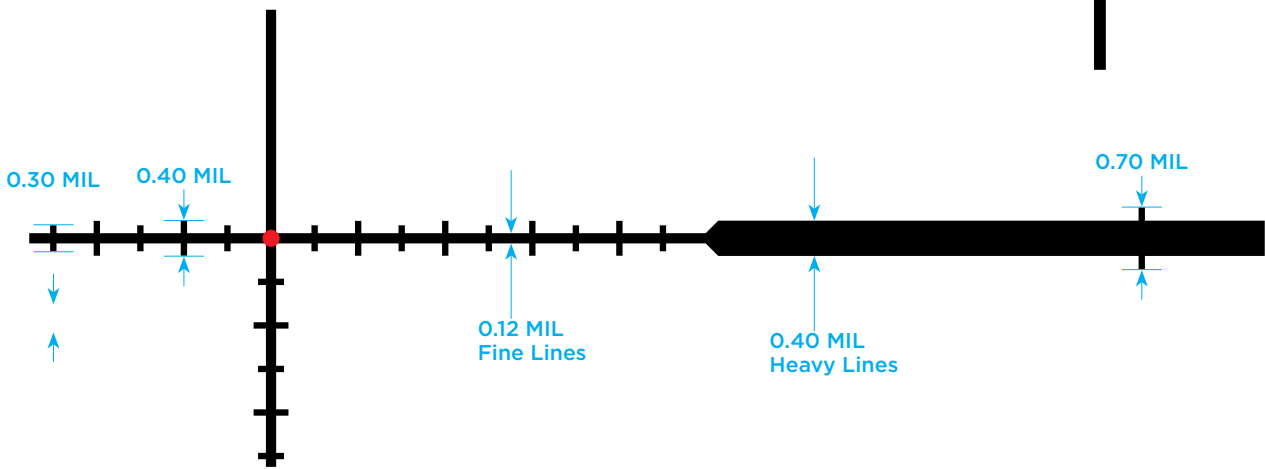
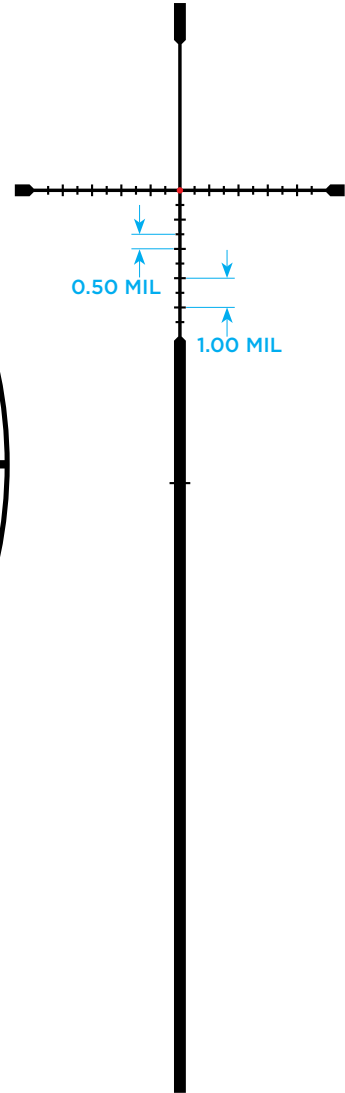



# ILLUM. FIREDOT TRI-MOA

VX-6HD, VX-FREEDOM

## FULL RETICLE

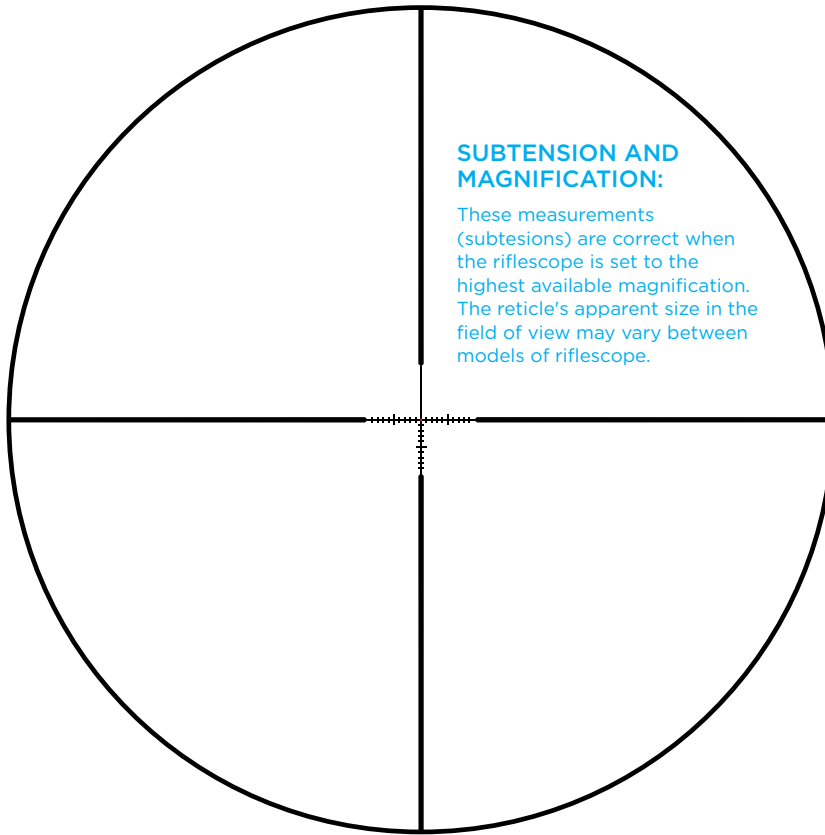

### SUBTENSION AND MAGNIFICATION:

These measurements (subtensions) are correct when the riflescope is set to the highest available magnification. The reticle's apparent size in the field of view may vary between models of riflescope.

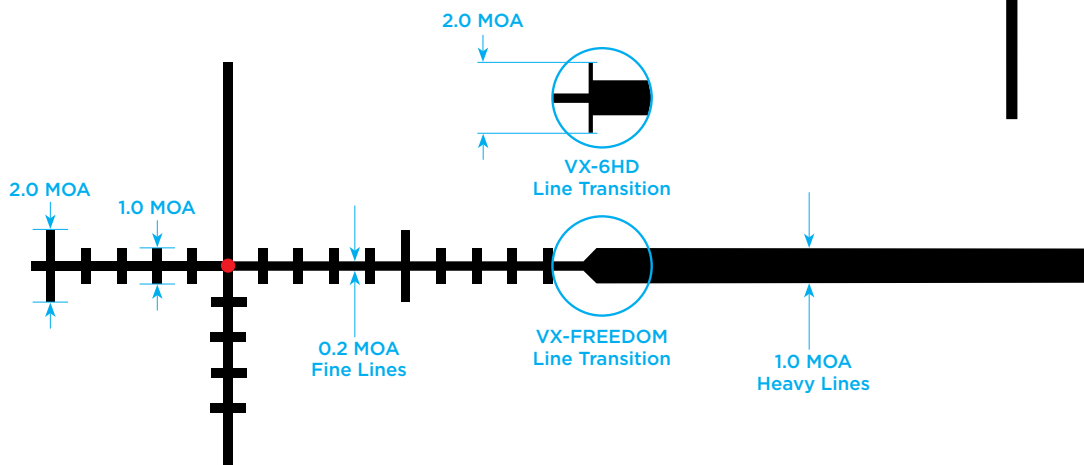
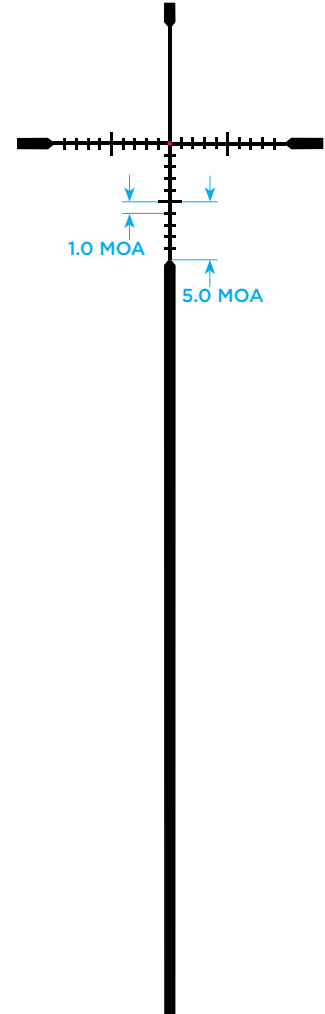

# IMPACT-23 MOA ILLUMINATED

VX-6HD

RETICLES

FULL RETICLE

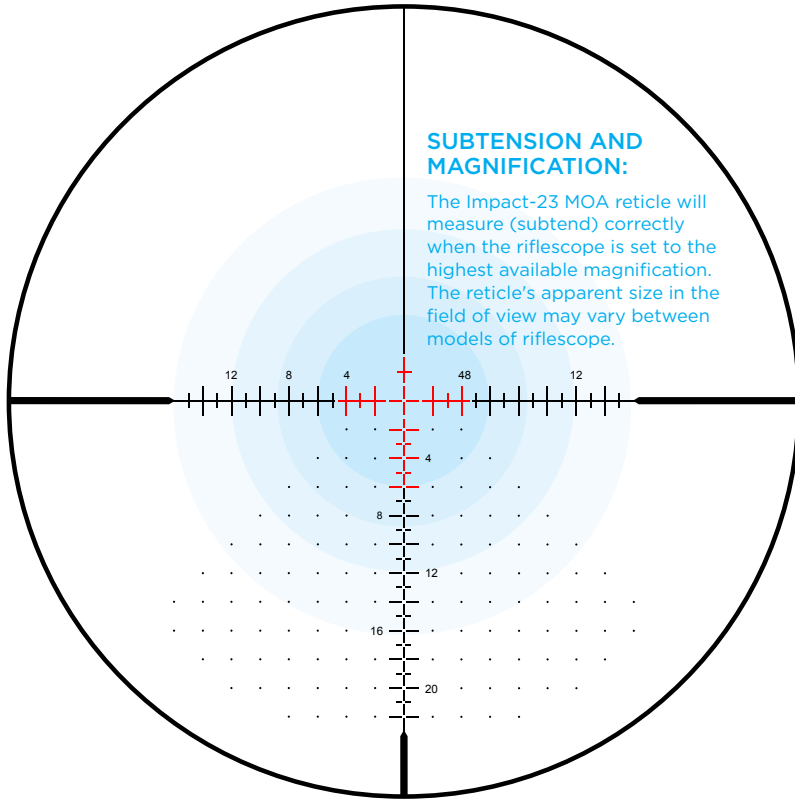

## SUBTENSION AND MAGNIFICATION:

The Impact-23 MOA reticle will measure (subtend) correctly when the riflescope is set to the highest available magnification. The reticle's apparent size in the field of view may vary between models of riflescope.

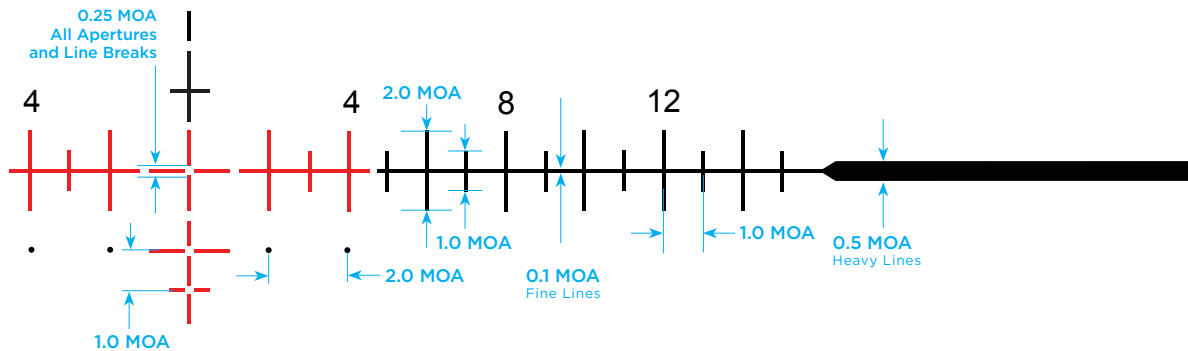
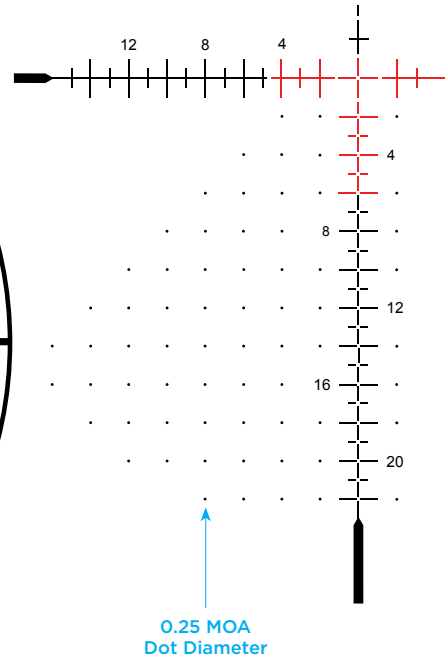

# IMPACT-14 MOA

VX-5HD

## FULL RETICLE

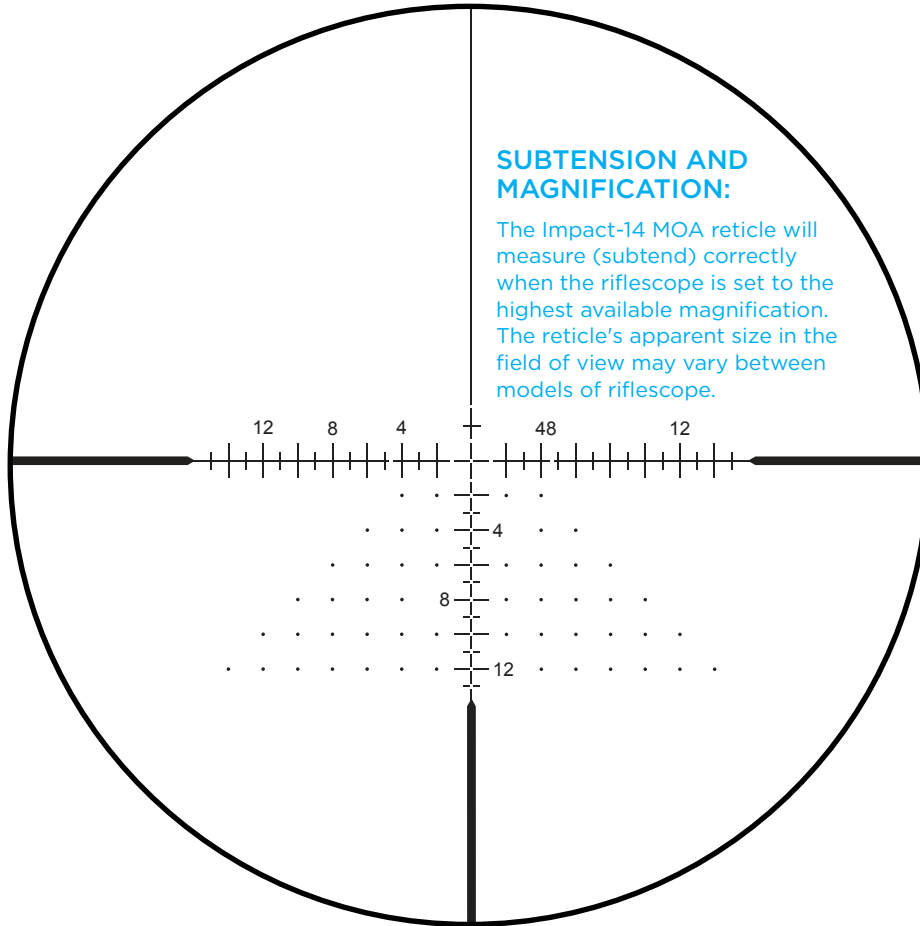

### SUBTENSION AND MAGNIFICATION:

The Impact-14 MOA reticle will measure (subtend) correctly when the riflescope is set to the highest available magnification. The reticle's apparent size in the field of view may vary between models of riflescope.

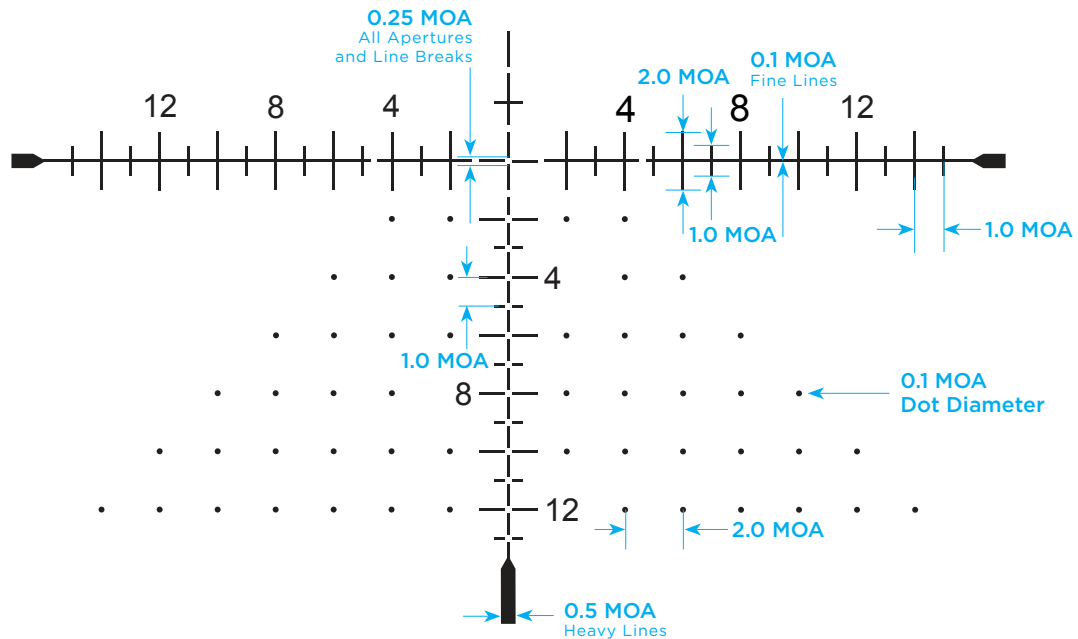

# IMPACT-29 MOA

VX-5HD, VX-3I LRP

RETICLES

FULL RETICLE

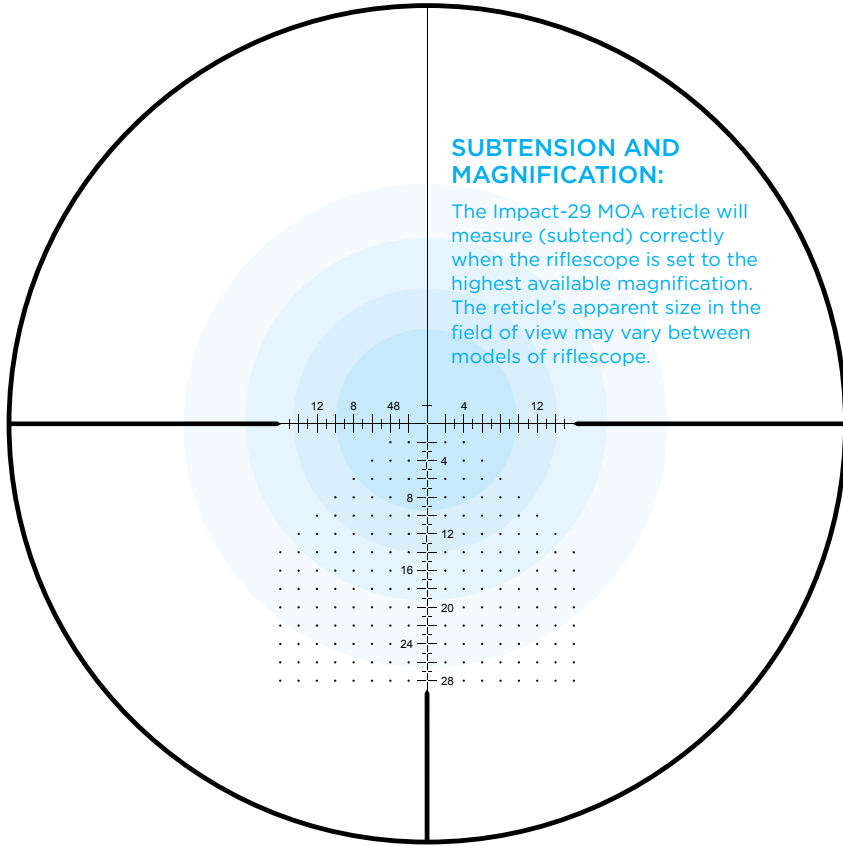

### SUBTENSION AND MAGNIFICATION:

The Impact-29 MOA reticle will measure (subtend) correctly when the riflescope is set to the highest available magnification. The reticle's apparent size in the field of view may vary between models of riflescope.

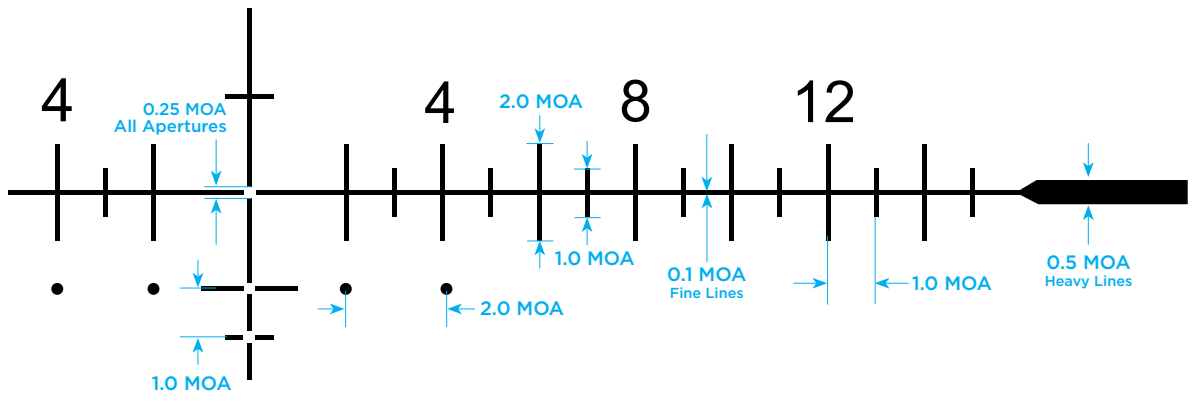
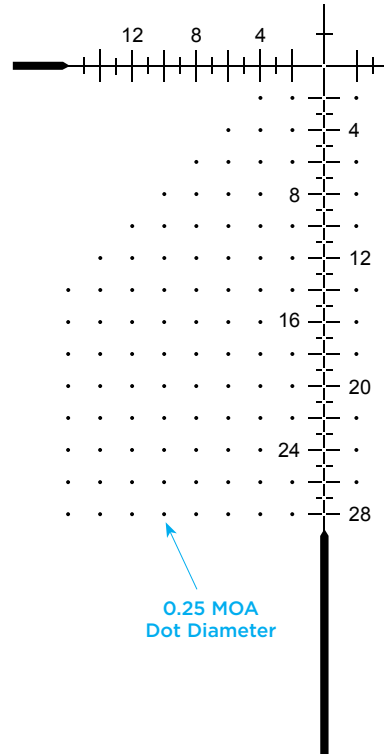

# IMPACT-32 MOA

VX-3I LRP

FULL RETICLE

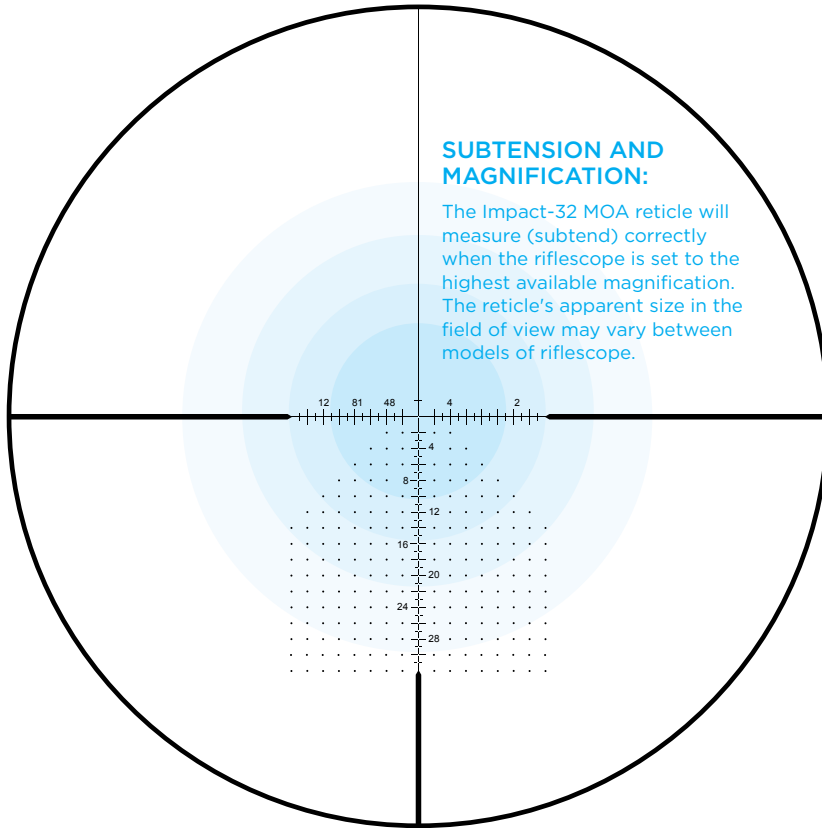

## SUBTENSION AND MAGNIFICATION:

The Impact-32 MOA reticle will measure (subtend) correctly when the riflescope is set to the highest available magnification. The reticle's apparent size in the field of view may vary between models of riflescope.

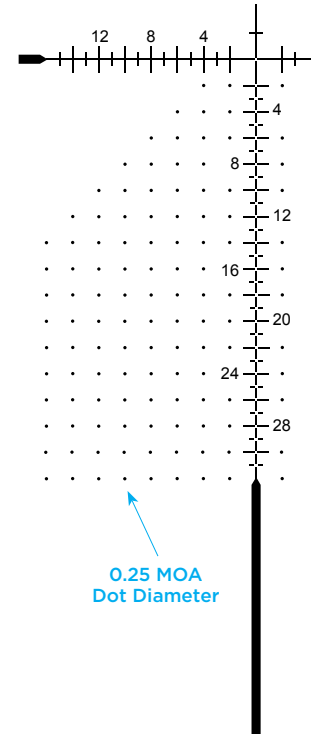

0.25 MOA  
Dot Diameter

12

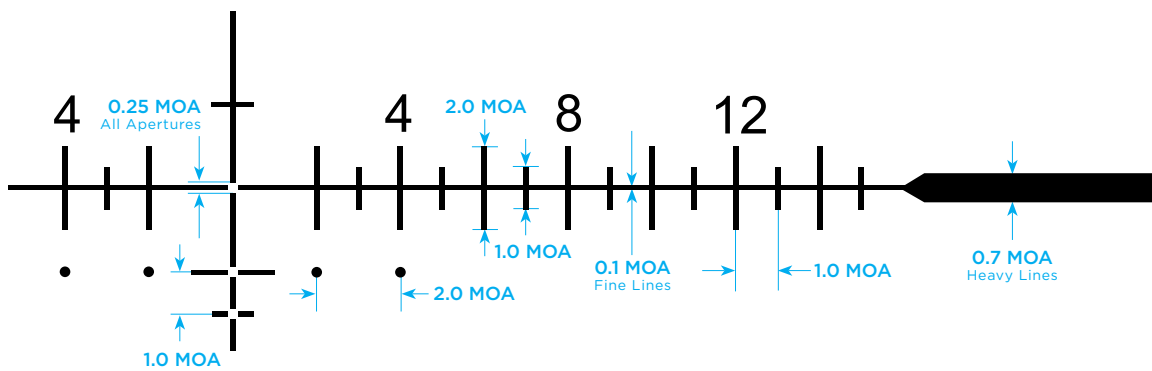

0.25 MOA  
All Apertures

1.0 MOA

2.0 MOA

2.0 MOA

0.1 MOA  
Fine Lines

12

1.0 MOA

0.7 MOA  
Heavy Lines

# RIMFIRE-MOA

VX-FREEDOM

RETICLES

FULL RETICLE

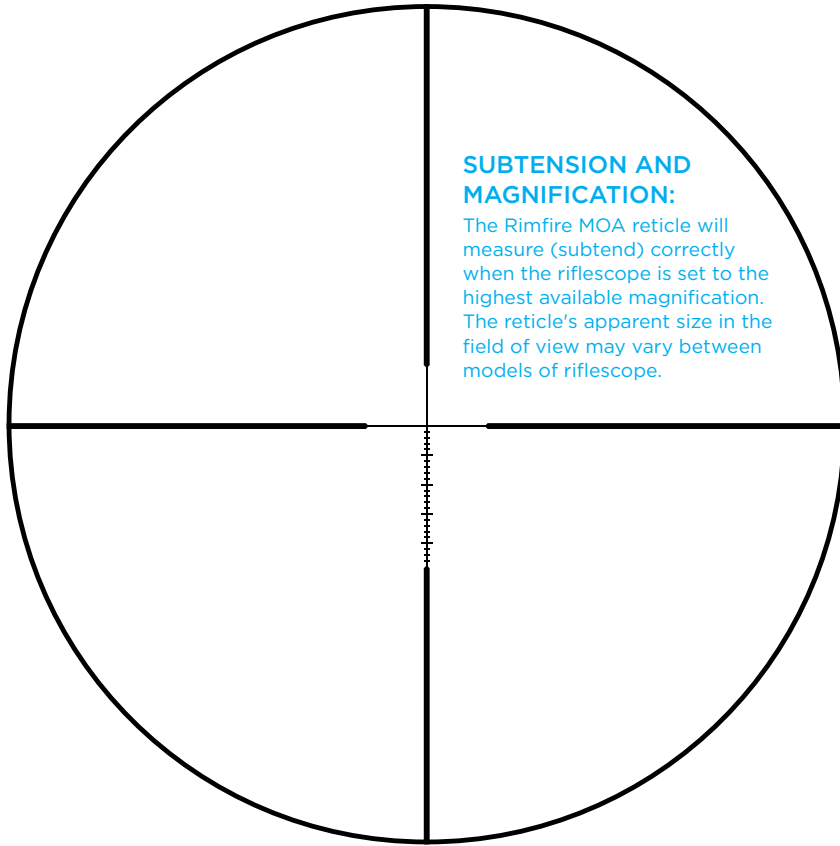

## SUBTENSION AND MAGNIFICATION:

The Rimfire MOA reticle will measure (subtend) correctly when the riflescope is set to the highest available magnification. The reticle's apparent size in the field of view may vary between models of riflescope.

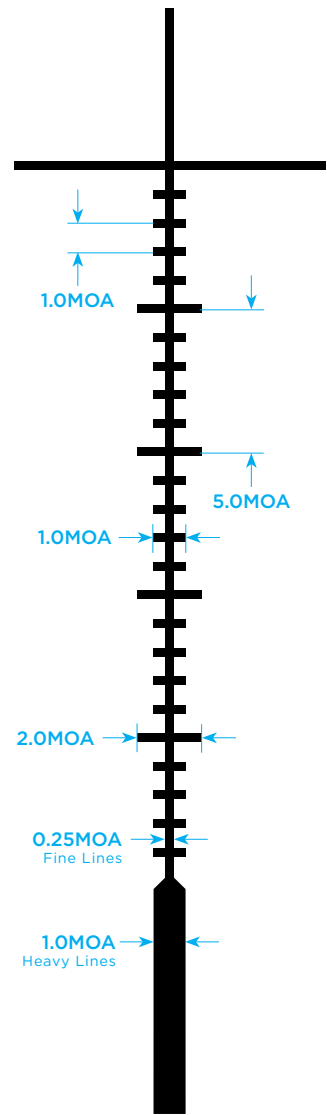

# ILLUMINATED TMOA

VX-6HD

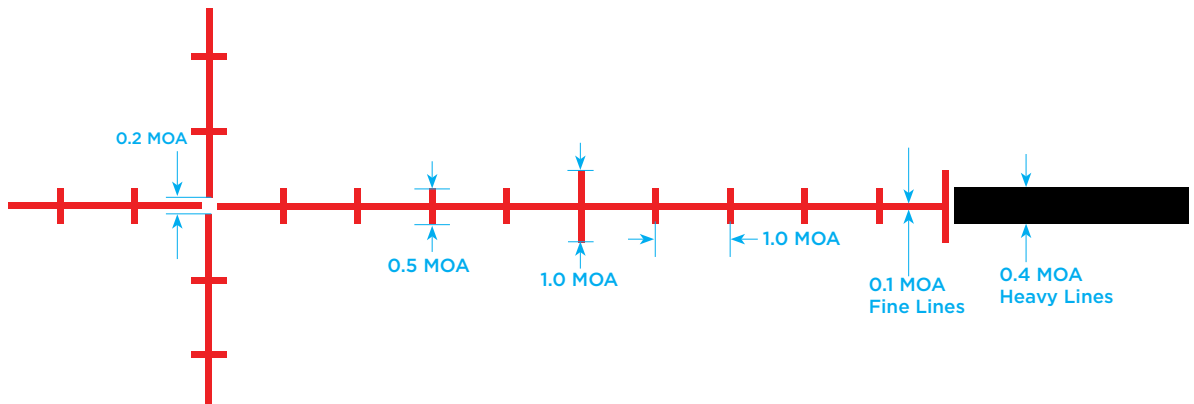
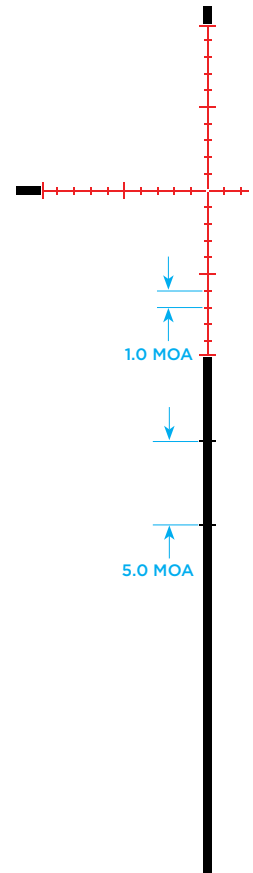
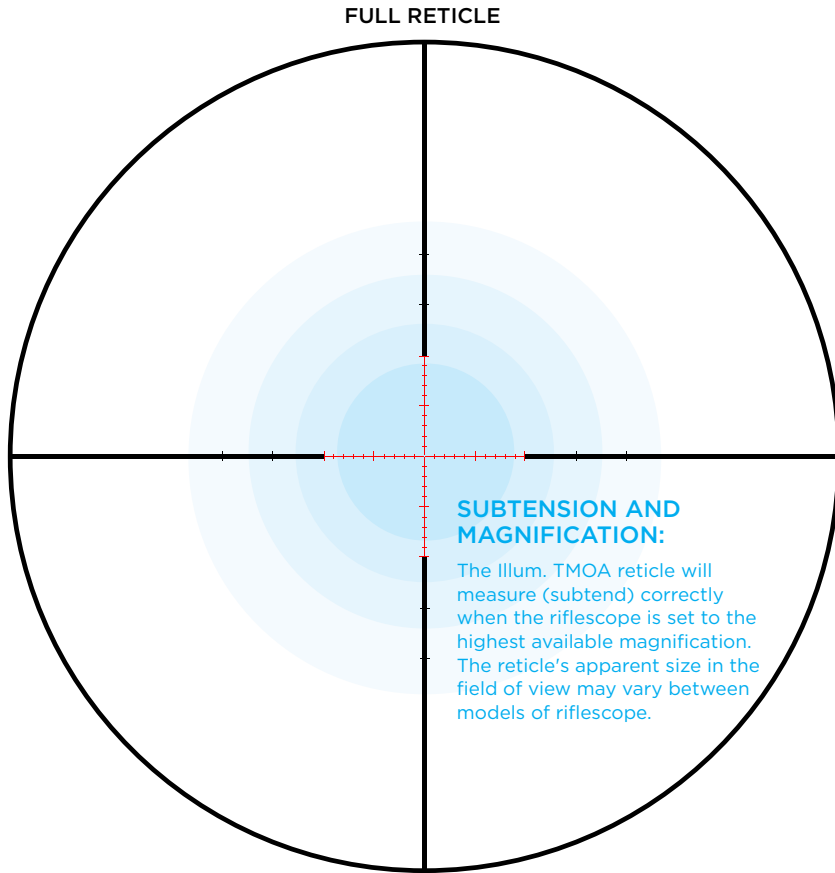

# TMOA PLUS

VX-5HD, MARK 5HD

RETICLES

FULL RETICLE

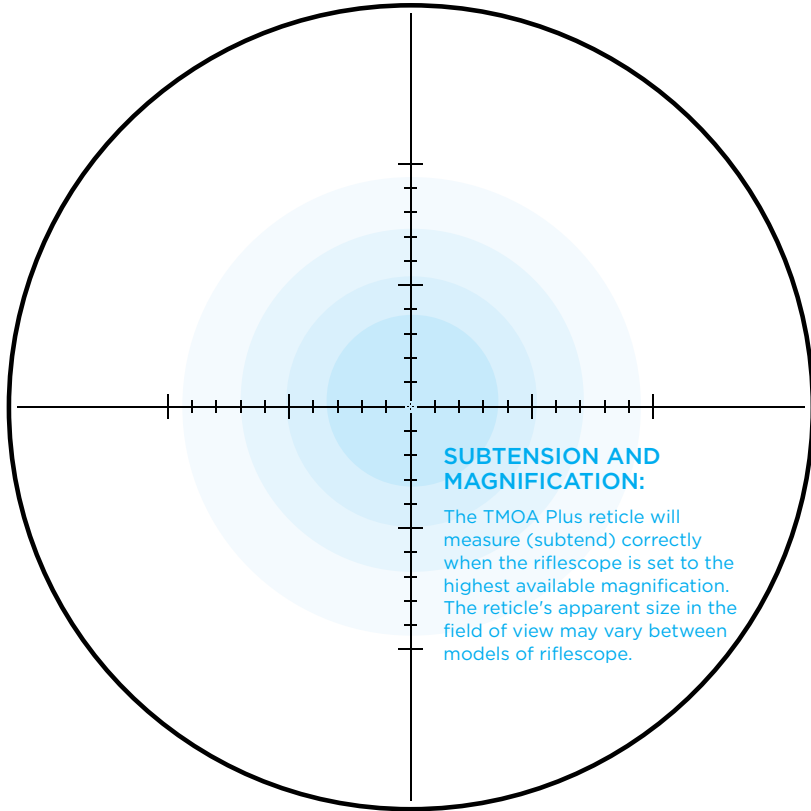

### SUBTENSION AND MAGNIFICATION:

The TMOA Plus reticle will measure (subtend) correctly when the riflescope is set to the highest available magnification. The reticle's apparent size in the field of view may vary between models of riflescope.

CENTER OF RETICLE

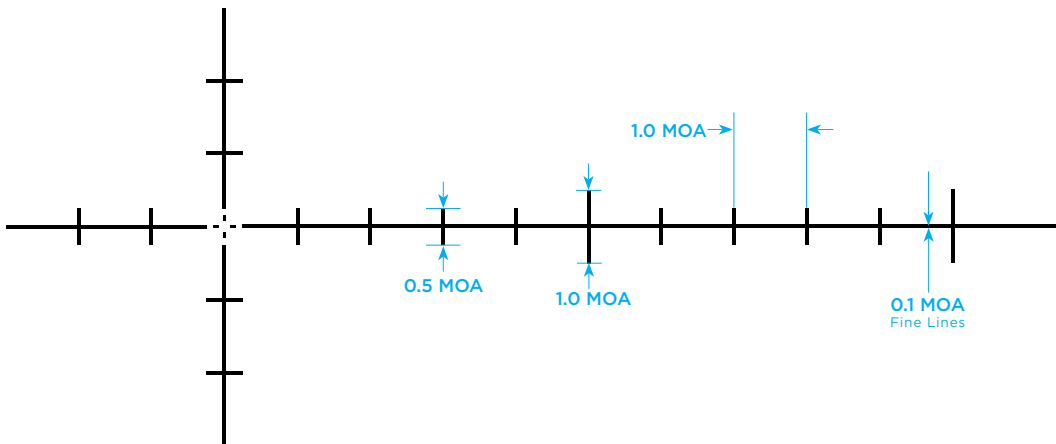
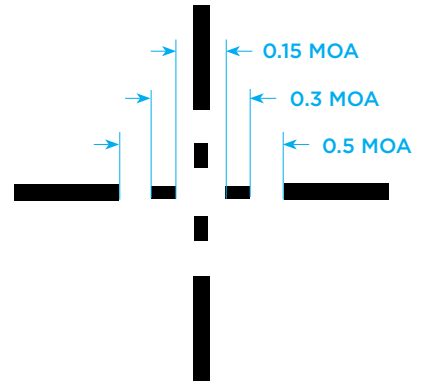



# TMOA

VX-5HD, VX-3I LRP

FULL RETICLE

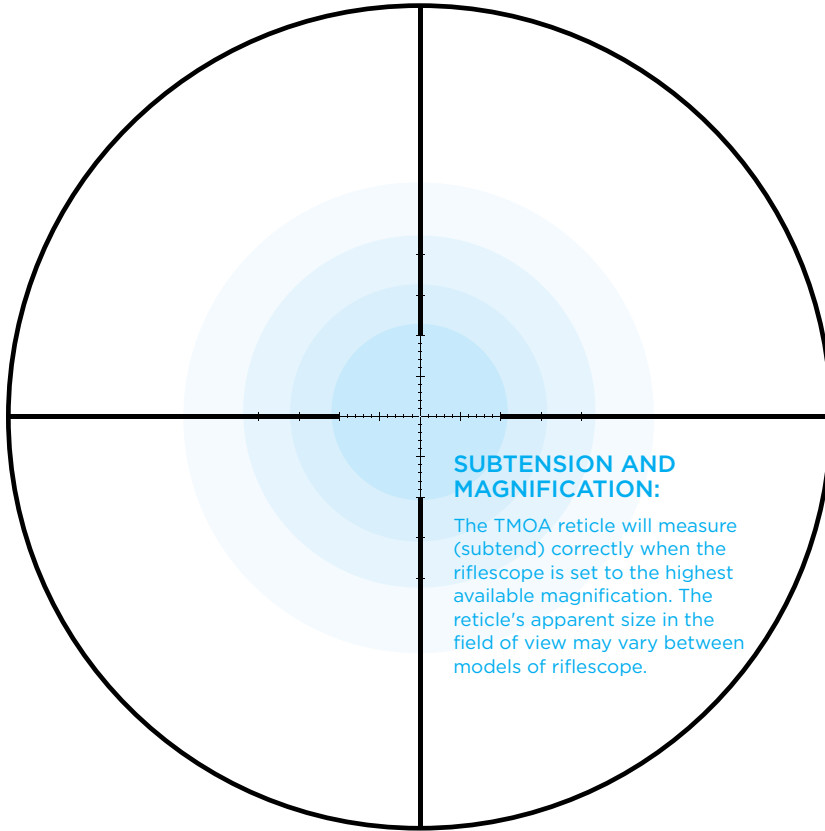

### SUBTENSION AND MAGNIFICATION:

The TMOA reticle will measure (subtend) correctly when the riflescope is set to the highest available magnification. The reticle's apparent size in the field of view may vary between models of riflescope.

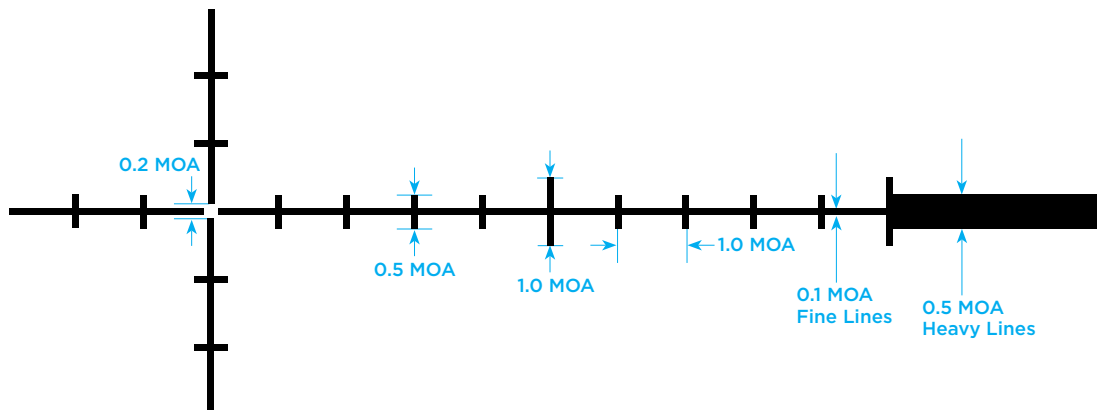
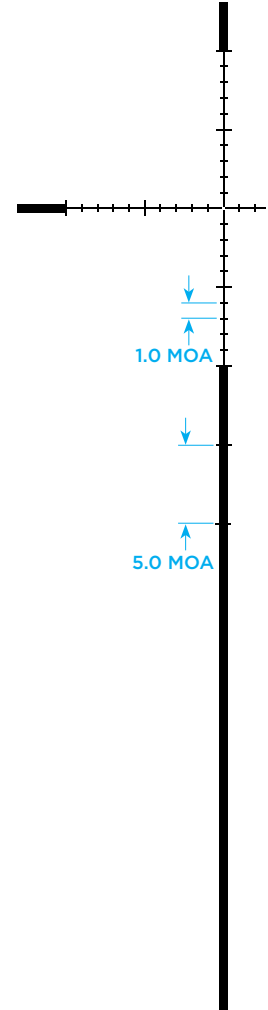

# TMR (VX-FREEDOM)

[TACTICAL MILLING RETICLE]

VX-FREEDOM

FULL RETICLE

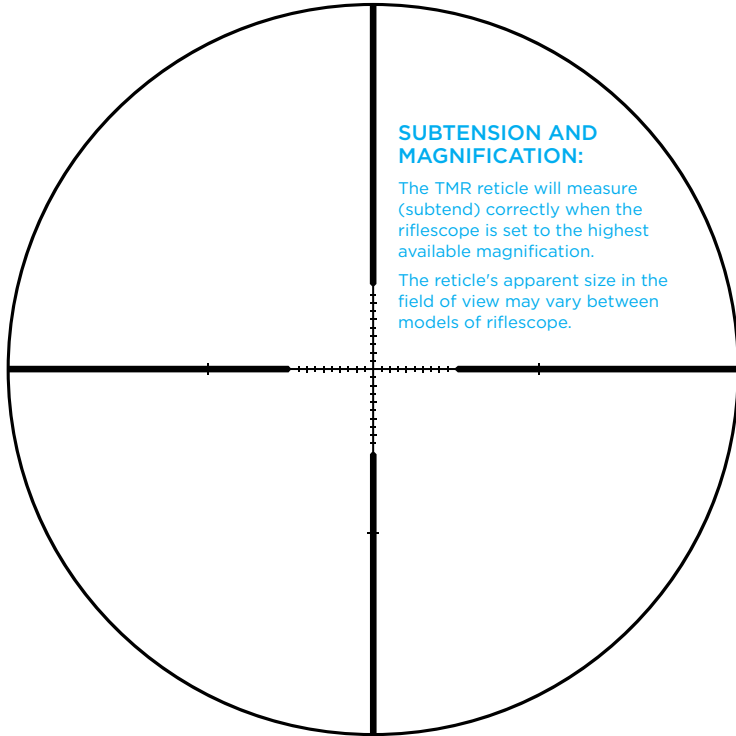

### SUBTENSION AND MAGNIFICATION:

The TMR reticle will measure (subtend) correctly when the riflescope is set to the highest available magnification.

The reticle's apparent size in the field of view may vary between models of riflescope.

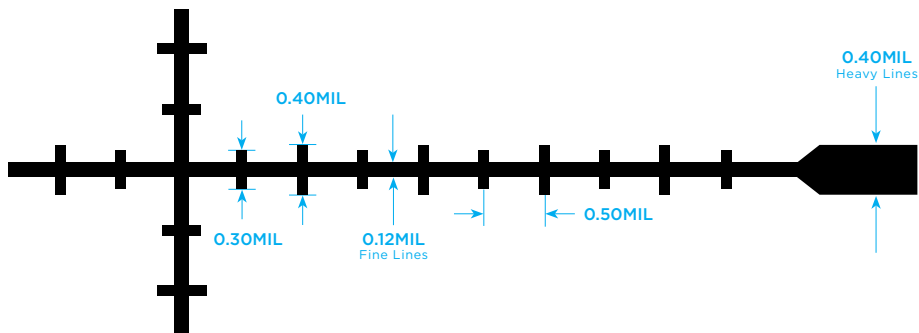
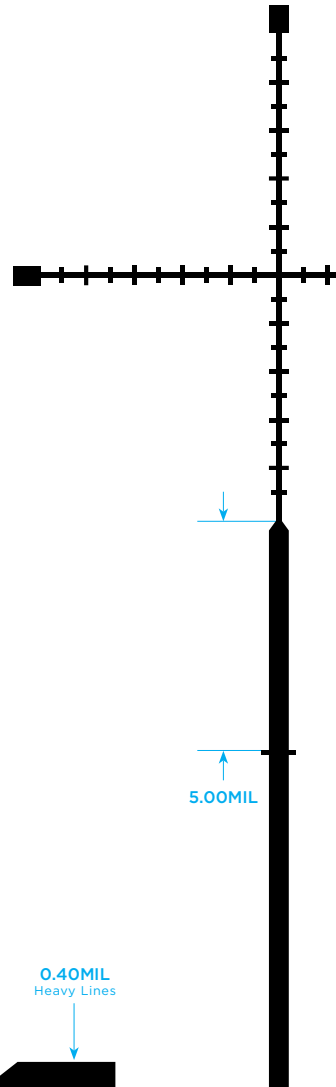

# TMR

[TACTICAL MILLING RETICLE]

VX-31 LRP

## FULL RETICLE

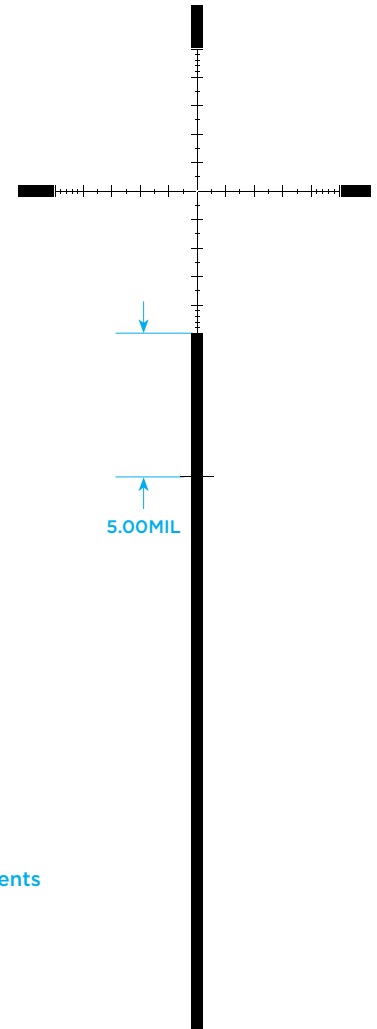
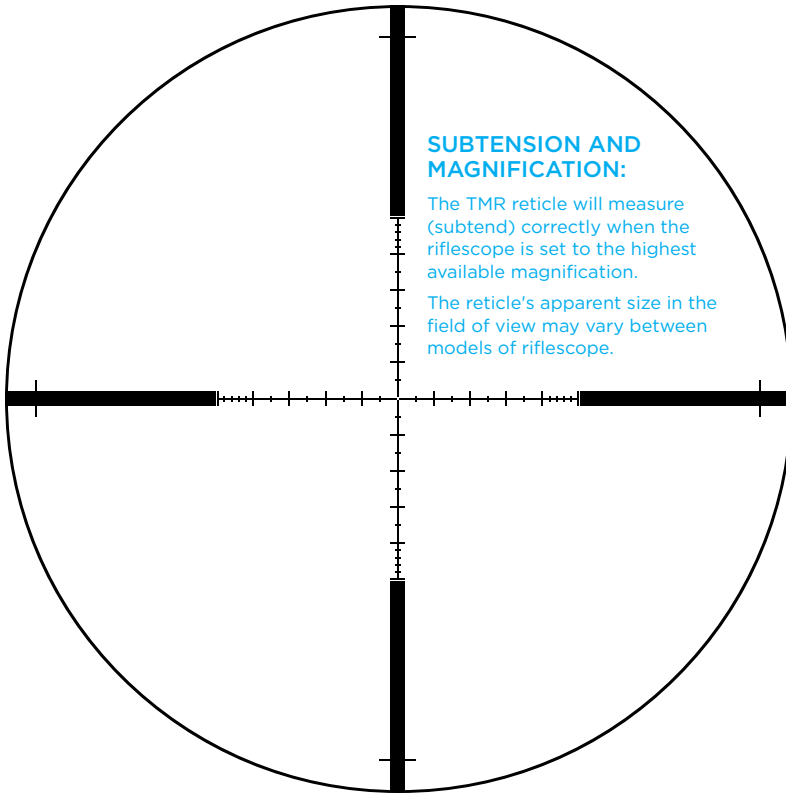

This reticle's center aperture has different requirements in scopes of these three power ranges.

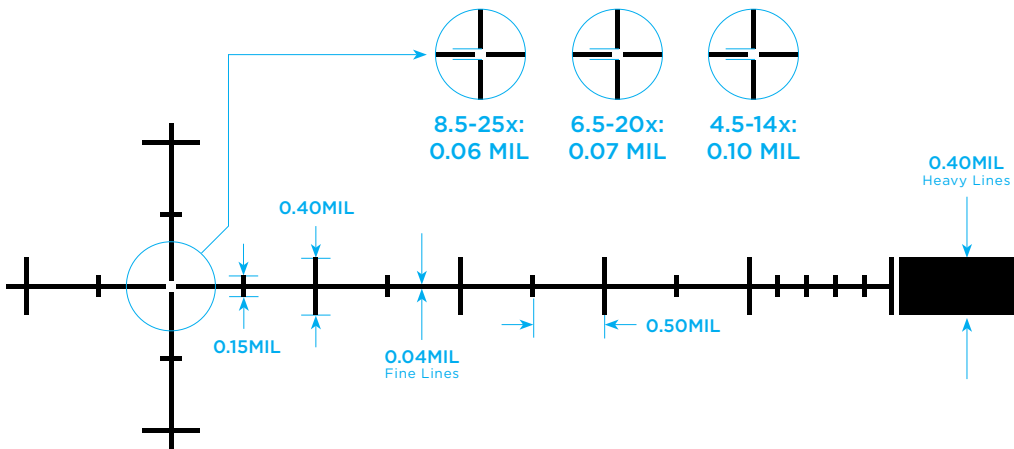

# TRI-MOA

VX-FREEDOM

RETICLES

## FULL RETICLE

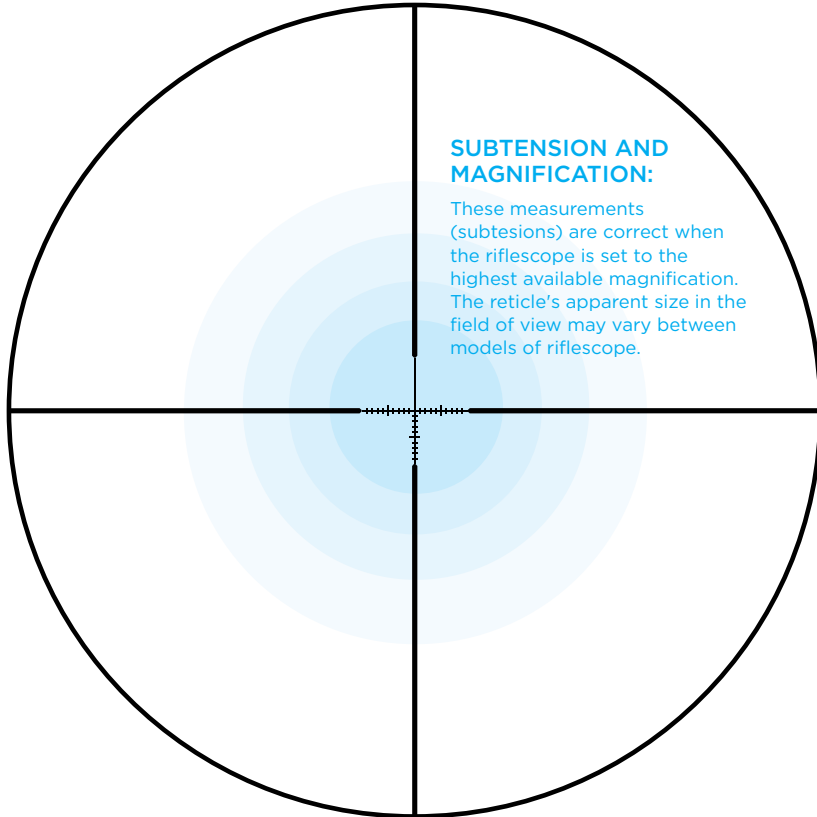

### SUBTENSION AND MAGNIFICATION:

These measurements (subtensions) are correct when the riflescope is set to the highest available magnification. The reticle's apparent size in the field of view may vary between models of riflescope.

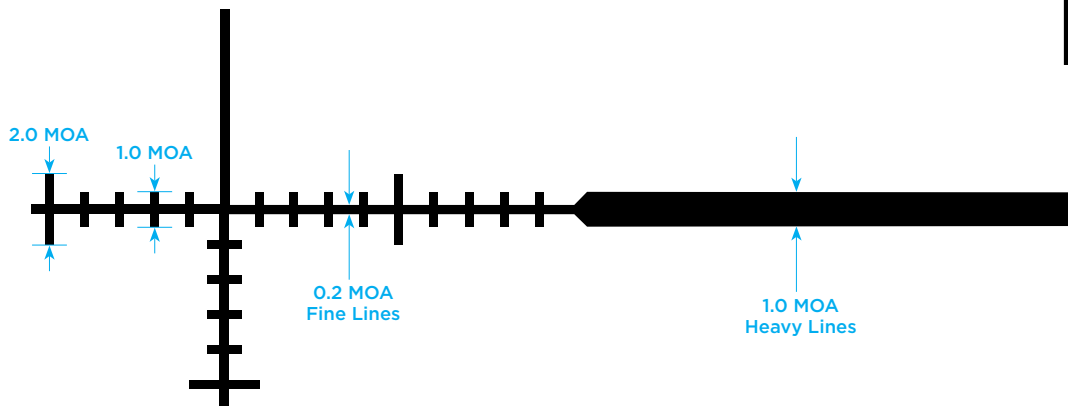
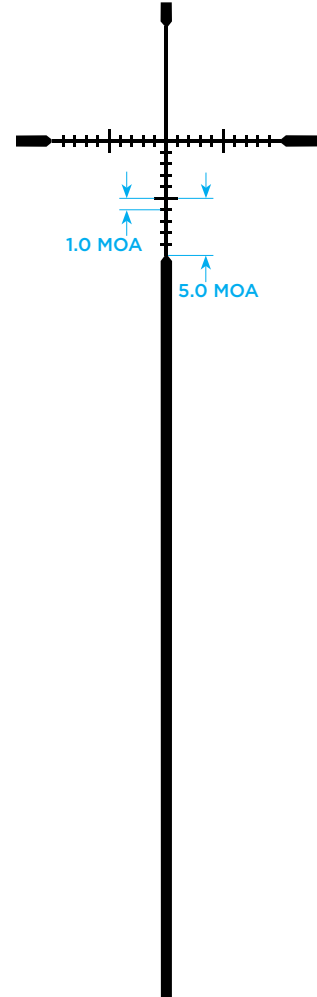

# ULTIMATESLAM

VX-FREEDOM

## FULL RETICLE

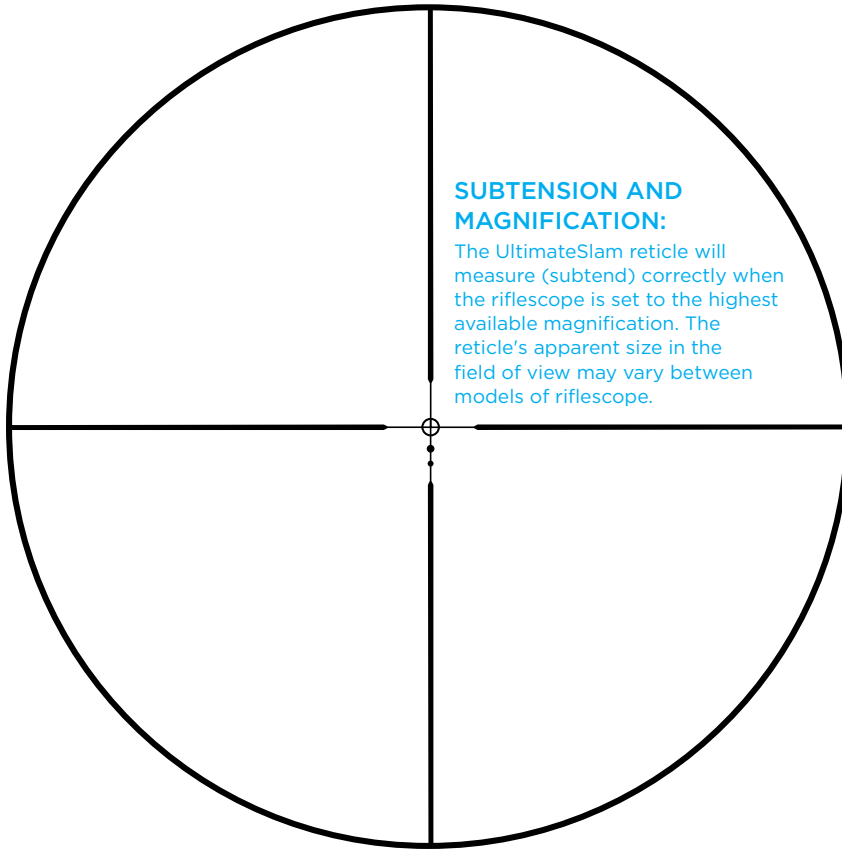

### SUBTENSION AND MAGNIFICATION:

The UltimateSlam reticle will measure (subtend) correctly when the riflescope is set to the highest available magnification. The reticle's apparent size in the field of view may vary between models of riflescope.

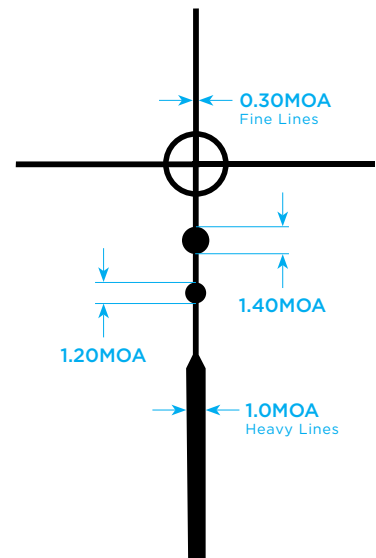
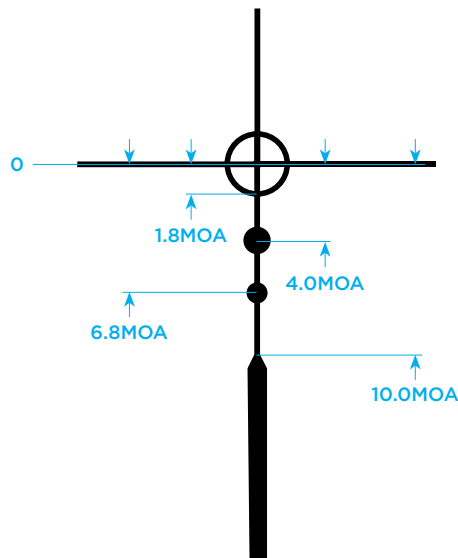

# WIND-PLEX

